

STIMEX

WORKSHAKER

STRIPES
L-SOFA/H-SOFA
PIVOT

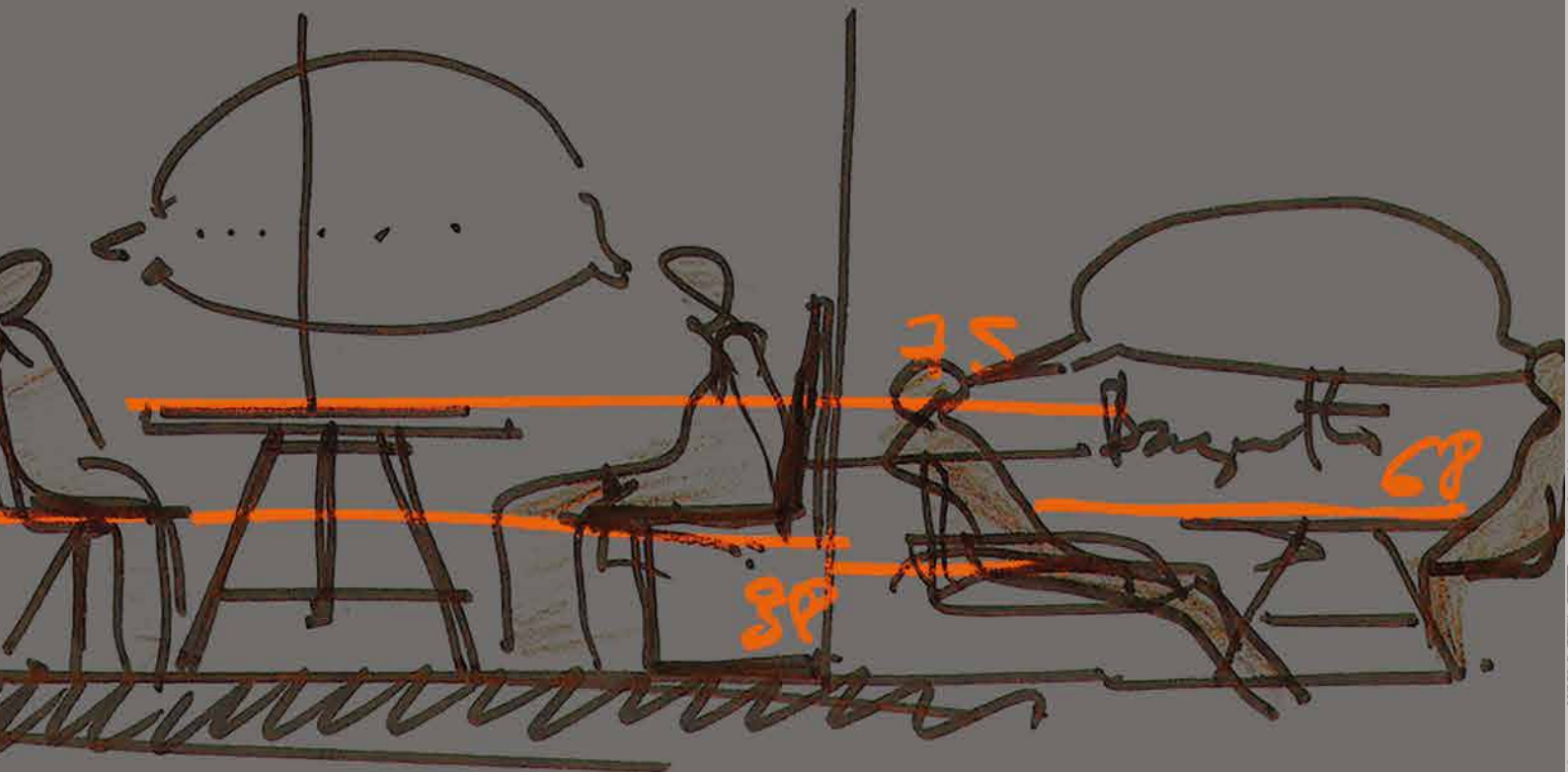

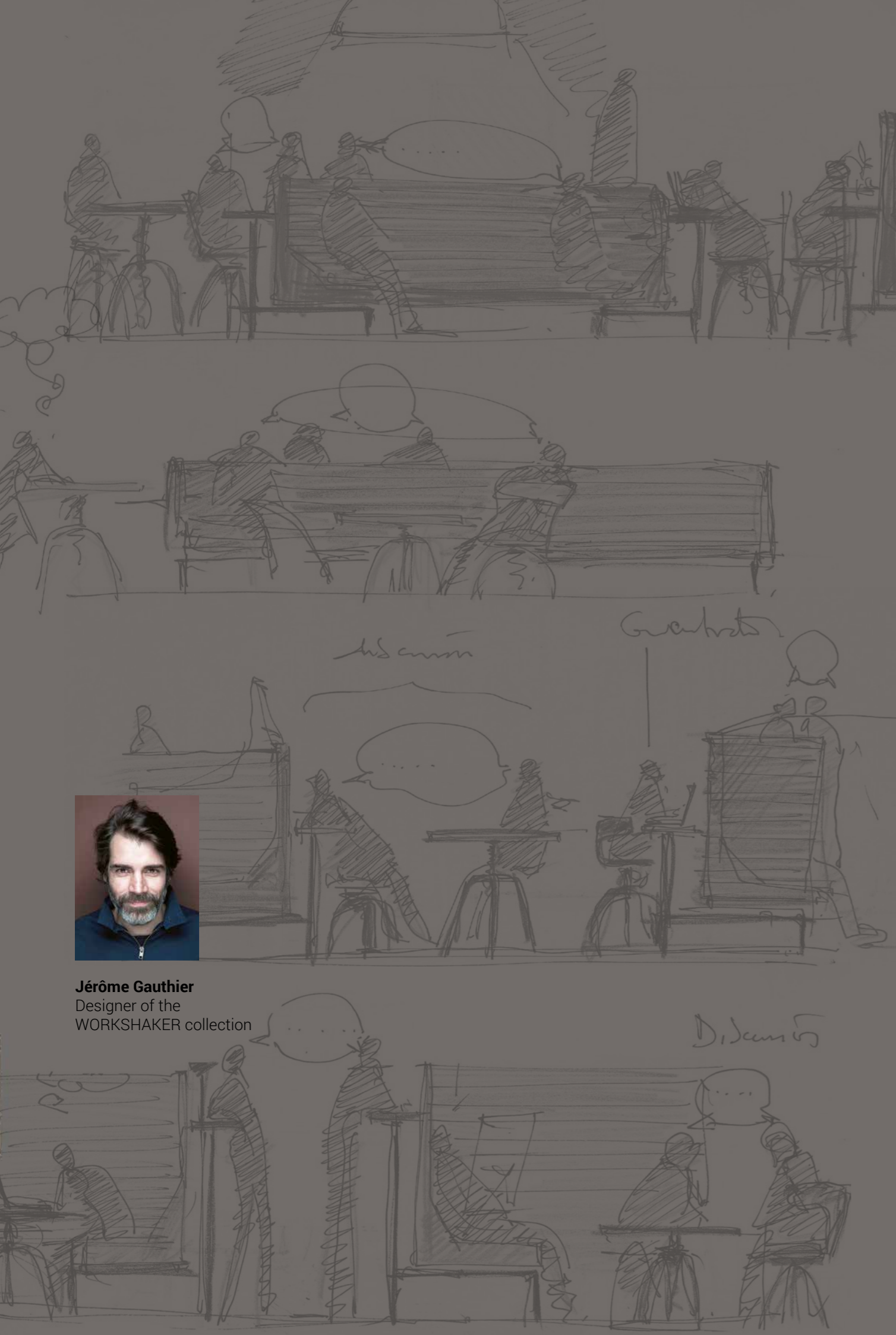

Jérôme Gauthier
Designer of the
WORKSHAKER collection

WORKSHAKER

STRIPES
L-SOFA/H-SOFA
PIVOT

With WORKSHAKER, based on the Stripes and L-Sofa models, Jérôme Gauthier proposes professional environments suited to workers' highly-evolved tools and methods. Characterized by phonic and visual insulation conducive to reflection, collective meeting zones and individual work zones cohabit in the same optimized space. The alternating horizontal supports (seat, table and tray) and the vertical surfaces (file partitioning) encourage a variety of postures in a multitude of situations.

This diversity of spatial positions – face to face, side by side, back to back – and the quality of exchanges it allows, is enriched by the rotating seat and the height adjustable table Pivot, linked to the Stripes Back Tray and L-Sofa Light. Integrated solutions for electrical and computer connections facilitate the use of tables and trays. Independent electrical and lighting additions augment connection possibilities and users' mobility. Marelli introduces a mix of versatile and easily expandable organizational solutions to furnish easy to access and use work spaces.



STRIPES sofa 9SS305 cm 145x73x133h in Camira fabric cat. B art.
Xtreme Plus col. Panama YS079, with OPM1 shiny chrome metal base.



STRIPES sofa 9SS305 cm 145x73x133h in Camira fabric cat. B art. Xtreme Plus col. Panama YS079, with OPM1 shiny chrome metal base.



STRIPES customized composition cm 900x73x133h in leather cat. Super art. Dollaro col. 7290, with RAL 9006 white aluminium painted metal bases.





Front sofa: **STRIPES** sofa 9SS208 cm 185x73x133h with external part in Camira fabric cat. E art. Blazer II col. Silverdale CUZ28, seat in fabric cat. B Xtreme Plus col. Diablo YS101 and backrest in fabric cat. B art. Xtreme Plus col. Panama YS079; OPM1 shiny chrome metal base.

STRIPES Y-shaped **composition "A"** made of 2 elements with left armrest and 2 elements with right armrest 9SS604 cm 225/185x73x101h with an angle of 60° in Gabriel fabric cat. B art. Atlantic col. 64116, 2 low shelves 9SS809 in HPL in colour 1661 and small cushions 9RL112 cm 63x33 in fabric cat. B art. Atlantic col. 62048, with OPM6 RAL 9017 black painted metal bases. Belux lamps 9SS805, Schulte Evoline socket 9SS802, mobile shelf 9SS806 and mobile socket 9SS801. **PIVOT** swivel armchair 9PIV101 cm 55.5x54x80h with natural oak structure and seat and back in fabric cat. B art. Atlantic in the colours 64116 red and 62048 green; **PIVOT** tables 7PIV101 ø cm 60x43/61h in natural oak.

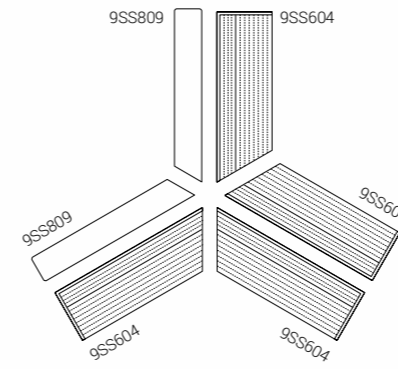



STRIPES Y-shaped composition "A"

made of 2 elements with left armrest and 2 elements with right armrest 9SS604 cm 225/185x73x101h with an angle of 60° in Gabriel fabric cat. B art. Atlantic col. 64116, 2 low shelves 9SS809 in HPL in colour 1661 and small cushions 9RL112 cm 63x33 in fabric cat. B art. Atlantic col. 62048, with OPM6 RAL 9017 black painted metal bases. Belux lamps 9SS805, Schulte Evoline socket 9SS802, mobile shelf 9SS806 and mobile socket 9SS801. **PIVOT** swivel armchair 9PIV101 cm 55.5x54x80h with natural oak structure and seat and back in fabric cat. B art. Atlantic in the colours 64116 red and 62048 green; **PIVOT** tables 7PIV101 ø cm 60x43/61h in natural oak.

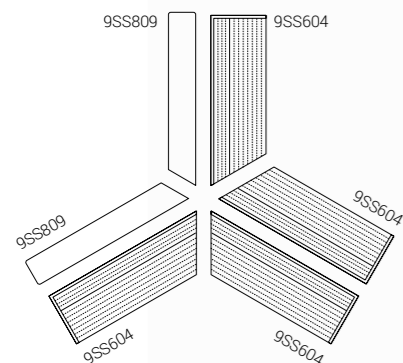

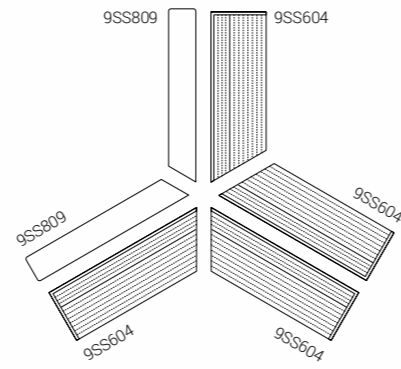

STRIPES Y-shaped **composition "A"** made of 2 elements with left armrest and 2 elements with right armrest 9SS604 cm 225/185x73x101h with an angle of 60° in Gabriel fabric cat. B art. Atlantic col. 64116, 2 low shelves 9SS809 in HPL in colour 1661 and small cushions 9RL112 cm 63x33 in fabric cat. B art. Atlantic col. 62048, with OPM6 RAL 9017 black painted metal bases. Belux lamps 9SS805, Schulte Evoline socket 9SS802, mobile shelf 9SS806 and mobile socket 9SS801. **PIVOT** swivel armchair 9PIV101 cm 55.5x54x80h with natural oak structure and seat and back in fabric cat. B art. Atlantic in the colours 64116 red and 62048 green; **PIVOT** tables 7PIV101 ø cm 60x43/61h in natural oak.



Detail of **STRIPES** Y-shaped **composition "A"** in Gabriel fabric cat. B art. Atlantic col. 64116 with low shelves 9SS809 in HPL in colour 1661, Belux lamps 9SS805, Schulte Evoline sockets 9SS802, mobile socket 9SS801 and **PIVOT** swivel armchair 9PIV101 with back and seat in fabric cat. B art. Atlantic col. 64116 and structure in natural oak.





Detail of mobile socket 9SS801
on **STRIPES composition "A"**
in Gabriel fabric cat. B
art. Atlantic col. 64116.

STRIPES curved **composition "B"** with diameter cm 370 made of 2 curved elements with 1 arm 9SS908 and 1 curved element without arm 9SS907 in Gabriel fabric cat. B art. Atlantic col. 64116 with small cushions 9RL112 in the same fabric colour and in colour 61163. OPM6 RAL 9017 black painted metal bases.
PIVOT table 7PIV101 ø cm 60xh43/61 in natural oak.

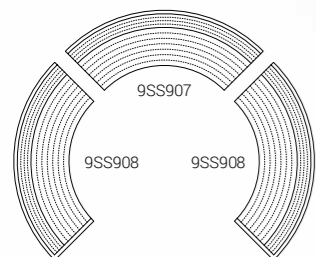

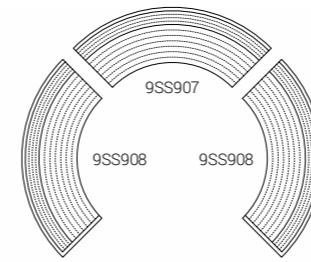

STRIPES curved **composition "B"** with diametre cm 370 made of 2 curved elements with 1 arm 9SS908 and 1 curved element without arm 9SS907 in Gabriel fabric cat. B art. Atlantic col. 64116 with small cushions 9RL112 in the same fabric colour and in colour 61163. OPM6 RAL 9017 black painted metal bases.
PIVOT table 7PIV101 ø cm 60xh43/61 in natural oak.





STRIPES composition "C" made of 2 sofas 9SS208 cm 185x73x133h in Gabriel fabric cat. B art. Atlantic col. 61163 with cushions 9RL112 cm 63x33 in fabric cat. B art. Atlantic col. 66086 with high shelf 9SS808 and table 9SS404X cm 82x133x133h in HPL in colour 1661. OPM6 black painted metal bases. Bachmann Power Frame electric module 9SS803, mobile lamp 9SS804, Belux lamp 9SS805 and Schulte Evoline socket 9SS802.

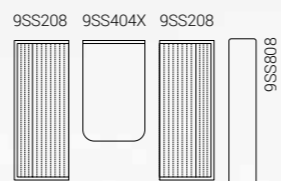

STRIPES composition "C" made of 2 sofas 9SS208 cm 185x73x133h in Gabriel fabric cat. B art. Atlantic col. 61078 with cushions 9RL112 cm 63x33 in fabric cat. B art. Atlantic col. 66086 with low shelf 9SS809 and table 9SS404X cm 82x133x133h in HPL in colour 1661. OPM6 black painted metal bases. Bachmann Power Frame electric module 9SS803, mobile lamp 9SS804, Belux lamp 9SS805 and Schulte Evoline socket 9SS802.

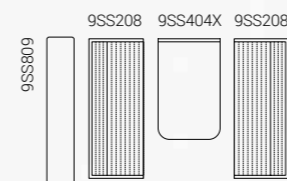

PIVOT swivel armchair 9PIV101 cm 55.5x54x80h with natural oak structure and seat and back in fabric cat. B art. Atlantic col. 66086.

STRIPES composition "C" made of 2 sofas 9SS208 cm 185x73x133h in Gabriel fabric cat. B art. Atlantic col. 61078, with cushions 9RL112 cm 63x33 in fabric cat. B art. Atlantic col. 66086 with low shelf 9SS809 and table 9SS404X cm 82x133x133h in HPL in colour 1661. OPM6 black painted metal bases. Bachmann Power Frame electric module 9SS803, mobile lamp 9SS804, Belux lamp 9SS805 and Schulte Evoline socket 9SS802.

PIVOT swivel armchair 9PIV101 cm 55.5x54x80h with natural oak structure and seat and back in fabric cat. B art. Atlantic col. 66086.

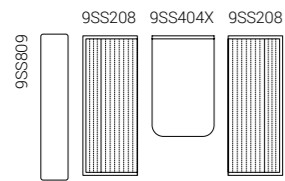

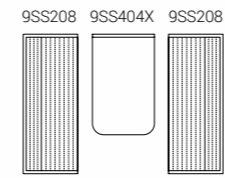

Detail of **STRIPES composition "C"** made of 2 sofas 9SS208 cm 185x73x133h in Gabriel fabric cat. B art. Atlantic col. 61078 with cushions 9RL112 cm 63x33 in fabric cat. B art. Atlantic col. 66086, with table 9SS404X cm 82x133x133h in HPL in colour 1661. Bachmann Power Frame electric module 9SS803 and mobile lamp 9SS804.



STRIPES sofa 9SS208 cm 185x73x133h in Gabriel fabric cat. B art. Atlantic col. 61163 with high shelf 9SS808 in HPL in colour 1661, with OPM6 RAL 9017 black painted metal base, Belux lamp 9SS805 and mobile socket 9SS801. **STRIPES composition "C"** made of 2 sofas 9SS208 cm 185x73x133h in Gabriel fabric cat. B art. Atlantic col. 61078, with table 9SS404X cm 82x133x133h and low shelf 9SS809 in HPL in colour 1661 and with cushions 9RL112 cm 63x33 in fabric cat. B art. Atlantic col. 64116. OPM6 black painted metal bases. Belux lamp 9SS805 and Schulte Evoline socket 9SS802. **PIVOT** swivel armchairs 9PIV101 cm 55.5x54x80h with natural oak structure and back and seat in fabric cat. B art. Atlantic col. 64116 and **PIVOT** table 7PIV101 ø cm 60x43/61 in natural oak.

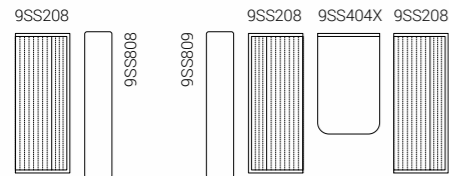

STRIPES composition "D" made of 2 sofas with 1 armrest 9SS210 cm 185x73x86h in Gabriel fabric cat. B art. Atlantic col. 61078 with low shelves 9SS809 in HPL in colour 1661, with OPM6 RAL 9017 black painted metal bases. Mobile shelf 9SS806, Belux lamps 9SS805 and mobile socket 9SS801. **PIVOT** swivel armchairs 9PIV101 cm 55.5x54x80h with natural oak structure and back and seat in fabric cat. B art. Atlantic col. 64116 red and 60063 beige and **PIVOT** table 7PIV101 ø cm 60x43/61 in natural oak.

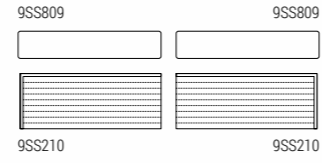

STRIPES composition "D" made of 2 sofas with 1 armrest 9SS210 cm 185x73x86h in Gabriel fabric cat. B art. Atlantic col. 61078 with low shelves 9SS809 in HPL in colour 1661, with OPM6 RAL 9017 black painted metal bases. Mobile shelf 9SS806, Belux lamps 9SS805 and mobile socket 9SS801. **PIVOT** swivel armchairs 9PIV101 cm 55.5x54x80h with natural oak structure and back and seat in fabric cat. B art. Atlantic col. 64116 red, 60063 beige and 61163 brown and **PIVOT** tables 7PIV101 ø cm 60x43/61 and 7PIV102 ø cm 78x43/74h in natural oak.

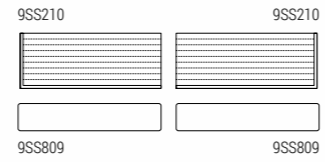

STRIPES composition "E" made of 2 corner elements 9SS401 cm 73x73x133h in Gabriel fabric cat. B art. Atlantic col. 60063 beige, with OPM6 RAL 9017 black painted metal base and table 9SS405X cm 82x55x133h in HPL in colour 1661.

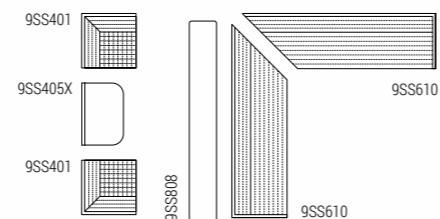

STRIPES composition "F" made of 2 sofas 9SS610 with 1 arm cm 255x73x133h with an angle of 45° in Gabriel fabric cat. B art. Atlantic col. 60063, with OPM6 RAL 9017 black painted metal bases. Small cushions 9RL112 cm 63x33 in fabric cat. B art. Atlantic col. 61163. High shelf 9SS808 in HPL in colour 1661 and Belux lamp 9SS805.

PIVOT swivel armchairs 9PIV101 55.5x54x80h with natural oak structure and seat and back in fabric cat. B art. Atlantic col. 60063 and 61163 and **PIVOT** tables 7PIV101 ø cm 60x43/61 and 7PIV102 ø cm 78x43/74h in natural oak.





STRIPES sofa with roof 9SS924 cm 185x73x183h in Gabriel fabric cat. B art. Atlantic col. 60063 with OPM6 RAL 9017 black painted metal base and **PIVOT** table 7PIV101 ø cm 60xh43/61 in natural oak.





STRIPES sofa 9SS305 cm 145x73x133h in Camira fabric cat. E art. Blazer col. Surrey CUZ1E with OPM6 RAL 9017 black painted metal base, with Bachmann Power Frame module 9SS807 and RAL 9017 black painted mobile writing shelf 9SS810.





STRIPES composition "G" made of 1 element 9SS401 cm 73x73x133h in Camira fabric cat. E art. Blazer col. Silcoates CUZ30 with RAL 9006 white aluminium painted base and 1 table 9SS403X cm 73x41x133h in white melamine with Bachmann Power Frame electric module 9SS803.



STRIPES composition "H" made of 2 elements 9SS401 cm 73x73x133h in Camira fabric cat. E art. Blazer col. Surrey CUZ1E with RAL 9006 white aluminium painted base and 1 table 9SS402X cm 82x55x133h in white melamine with Bachmann Power Frame electric module 9SS803.

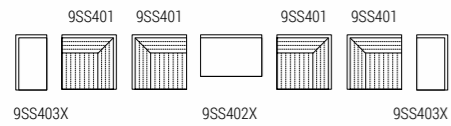

STRIPES composition made of 2 compositions "G" and 1 composition "H", as described above.



STRIPES sofas without arms 9SS201 cm 145x73x101h and bench 9SS101 cm 145x73x42.5h with vertical quilting in Camira fabric cat. E art. Blazer col. Silcoates CUZ30 with OPM6 RAL 9017 black painted metal bases. **STRIPES** sofas with 1 arm 9SS202 cm 145x73x101h with bench 9SS101 cm 145x73x42.5h with horizontal quilting in Camira fabric cat. E art. Blazer col. Bryanstom CUZ53 with OPM6 RAL 9017 black painted metal bases.



STRIPES is available with horizontal and, on demand, with vertical quilting.



STRIPES sofa without arms 9SS201 cm 145x73x101h and bench 9SS101 cm 145x73x42.5h with vertical quilting in Camira fabric cat. E art. Blazer col. Silcoates CUZ30 with OPM6 RAL 9017 black painted metal bases.

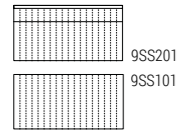

STRIPES sofas with 1 arm 9SS202 cm 145x73x101h in Camira fabric cat. E art. Blazer col. Bryanstom CUZ53 with OPM6 RAL 9017 black painted metal bases.



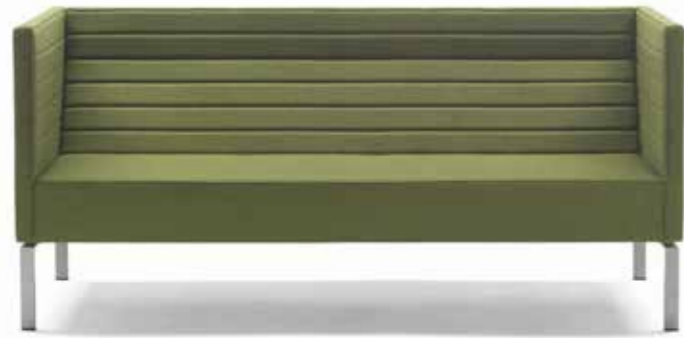

STRIPES sofa cm 145x73x86h in Camira fabric cat. E art. Blazer col. Bryanstom CUZ53 with RAL 9006 white aluminium painted metal base. **PIVOT** swivel armchair 9PIV101 55.5x54x80h with natural oak structure and seat and back in Camira fabric cat. E art. Blazer col. Silverdale CUZ28 and **PIVOT** table 7PIV101 ø cm 60x43/61 in natural oak.





STRIPES composition "J" made of 2 elements with 1 arm 9SS614 cm 225x73x101h with an angle of 60° and 1 element without arms 9SS615 cm 225x73x101h with an angle of 60° in Camira fabric cat. E art. Blazer col. Surrey CUZ1E, with OPM6 RAL 9017 black painted metal bases and back low shelves 9SS809 in HPL in colour 1661.

PIVOT swivel armchairs 9PIV101 55.5x54x80h with natural oak structure and seat and back in the same fabric and **PIVOT** tables 7PIV101 ø cm 60x43/61 and 7PIV102 ø cm 78x43/74h in natural oak.

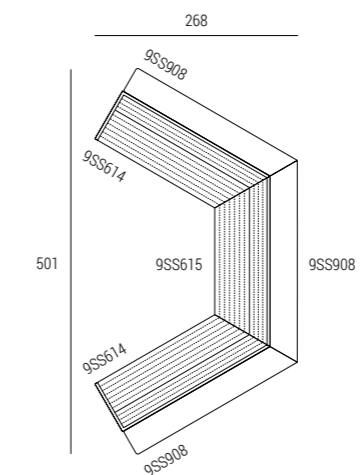

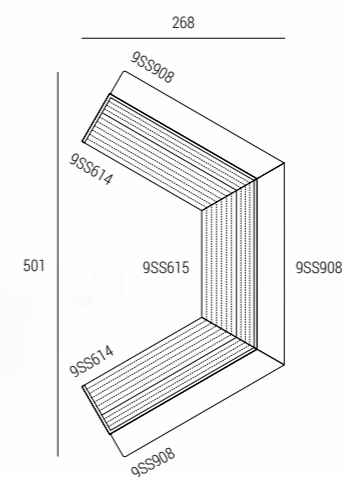
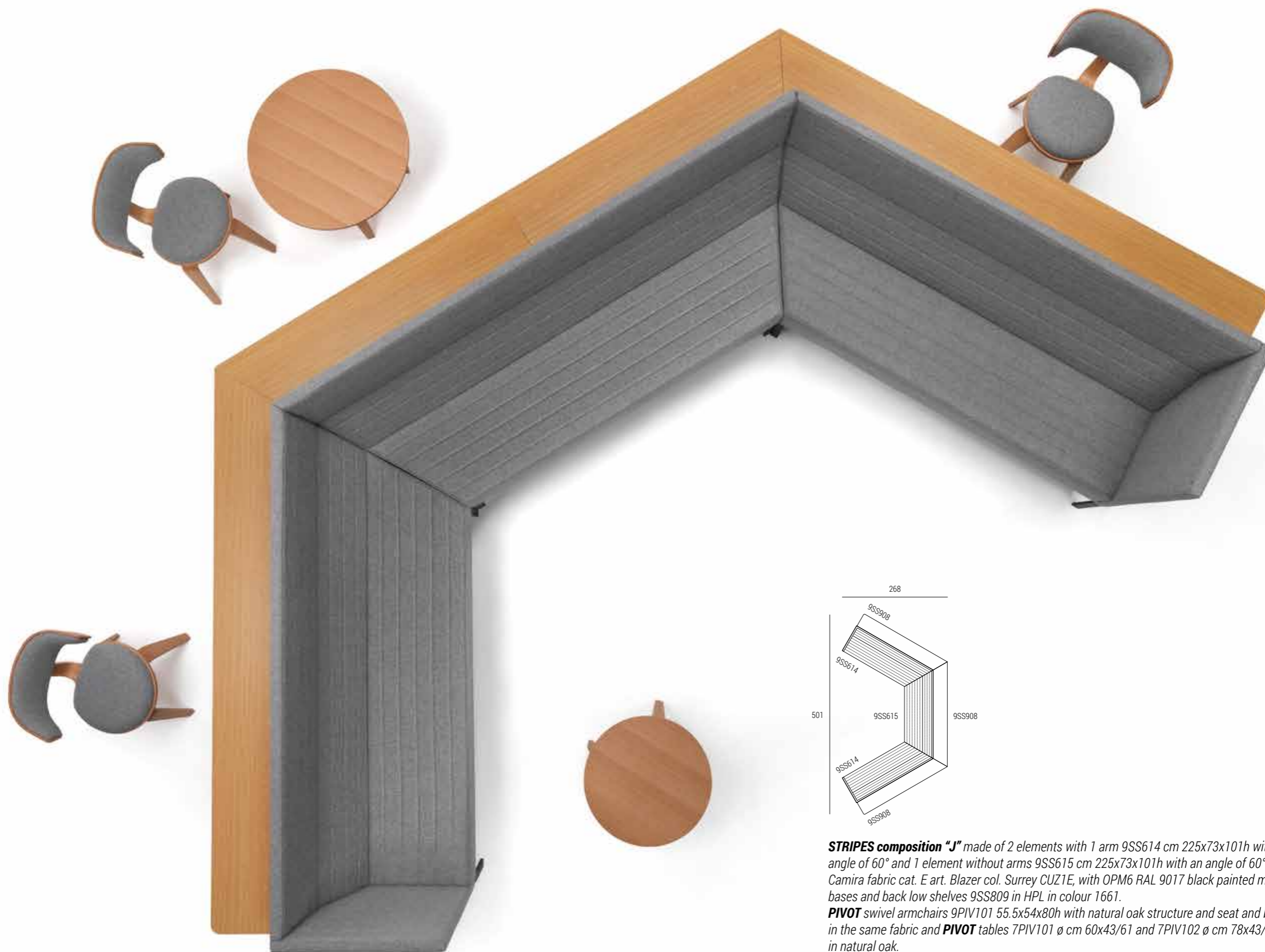

STRIPES composition "J" made of 2 elements with 1 arm 9SS614 cm 225x73x101h with an angle of 60° and 1 element without arms 9SS615 cm 225x73x101h with an angle of 60° in Camira fabric cat. E art. Blazer col. Surrey CUZ1E, with OPM6 RAL 9017 black painted metal bases and back low shelves 9SS809 in HPL in colour 1661.

PIVOT swivel armchairs 9PIV101 55.5x54x80h with natural oak structure and seat and back in the same fabric and **PIVOT** tables 7PIV101 ø cm 60x43/61 and 7PIV102 ø cm 78x43/74h in natural oak.

STRIPES composition "K" made of 1 sofa with 1 arm cm 185x73x133h, 1 curved element without arms 9SS909, 1 curved element without arms 9SS906 and 1 curved element without arms 9SS907 in Kvadrat fabric cat. H art. Steelcut Trio II col. 853, with OPM6 RAL 9017 black painted metal bases and low shelves 9SS809 in birch plywood natural oak veneered. Belux lamp 9SS805 and Schulte Evoline socket 9SS802.

PIVOT swivel armchair 9PIV101 55.5x54x80h with natural oak structure and seat and back in the same fabric and in Gabriel fabric cat. B art. Atlantic col. 61163 and **PIVOT** tables 7PIV101 ø cm 60x43/61 and 7PIV102 ø cm 78x43/74h in natural oak.

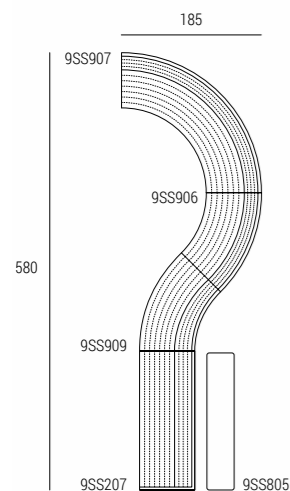

STRIPES composition "K" made of 1 sofa with 1 arm 9SS207 cm 185x73x133h, 1 curved element without arms 9SS909, 1 curved element without arms 9SS906 and 1 curved element without arms 9SS907 in Kvadrat fabric cat. H art. Steelcut Trio II col. 853, with OPM6 RAL 9017 black painted metal bases and low shelves 9SS809 in birch plywood natural oak veneered. Belux lamp 9SS805 and Schulte Evoline socket 9SS802. **PIVOT** swivel armchair 9PIV101 55.5x54x80h with natural oak structure and seat and back in the same fabric and in Gabriel fabric cat. B art. Atlantic col. 61163 and **PIVOT** tables 7PIV101 ø cm 60x43/61 and 7PIV102 ø cm 78x43/74h in natural oak.

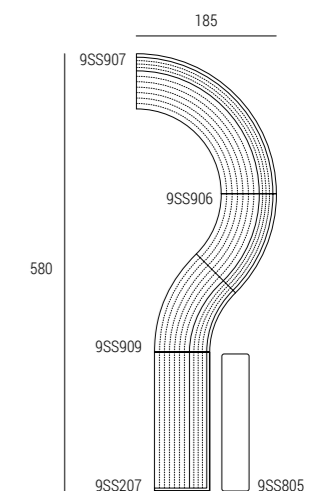

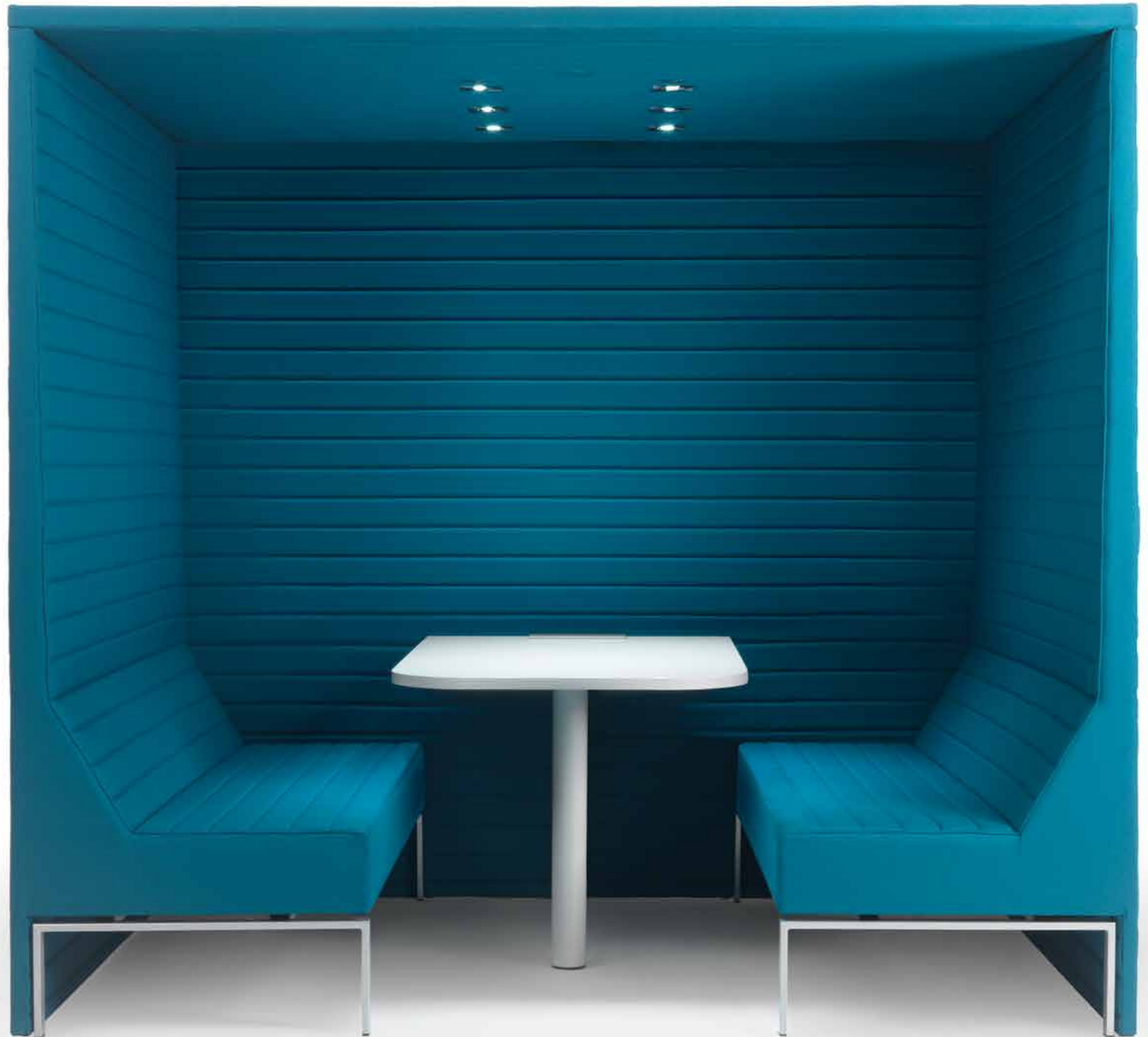

STRIPES box with led lighting 9SS916 cm
228x185x223h in Camira fabric cat. B art.
Xtreme Plus col. Tonga YS160 with OPM7
RAL 9016 white painted metal. Table in white
HPL and Bachmann power frame electric
module in the table 9SS803.

Activation of led lighting through motion
detector (standard version) or, on demand, by
means of a switch.

The standard equipment consists of 6 5W,
4000K, 420 Lumen LED spotlights, with
neutral white light and an angle of 45°.

<
 Detail of **STRIPES** box with led lighting
 9SS916 cm 228x185x223h.



STRIPES box 9SS917 cm 228x185x133h in Camira fabric cat. B art. Xtreme Plus col. Tonga YS160 with OPM7 RAL 9016 white painted metal. Table in white HPL and Bachmann power frame electric module in the table 9SS803.

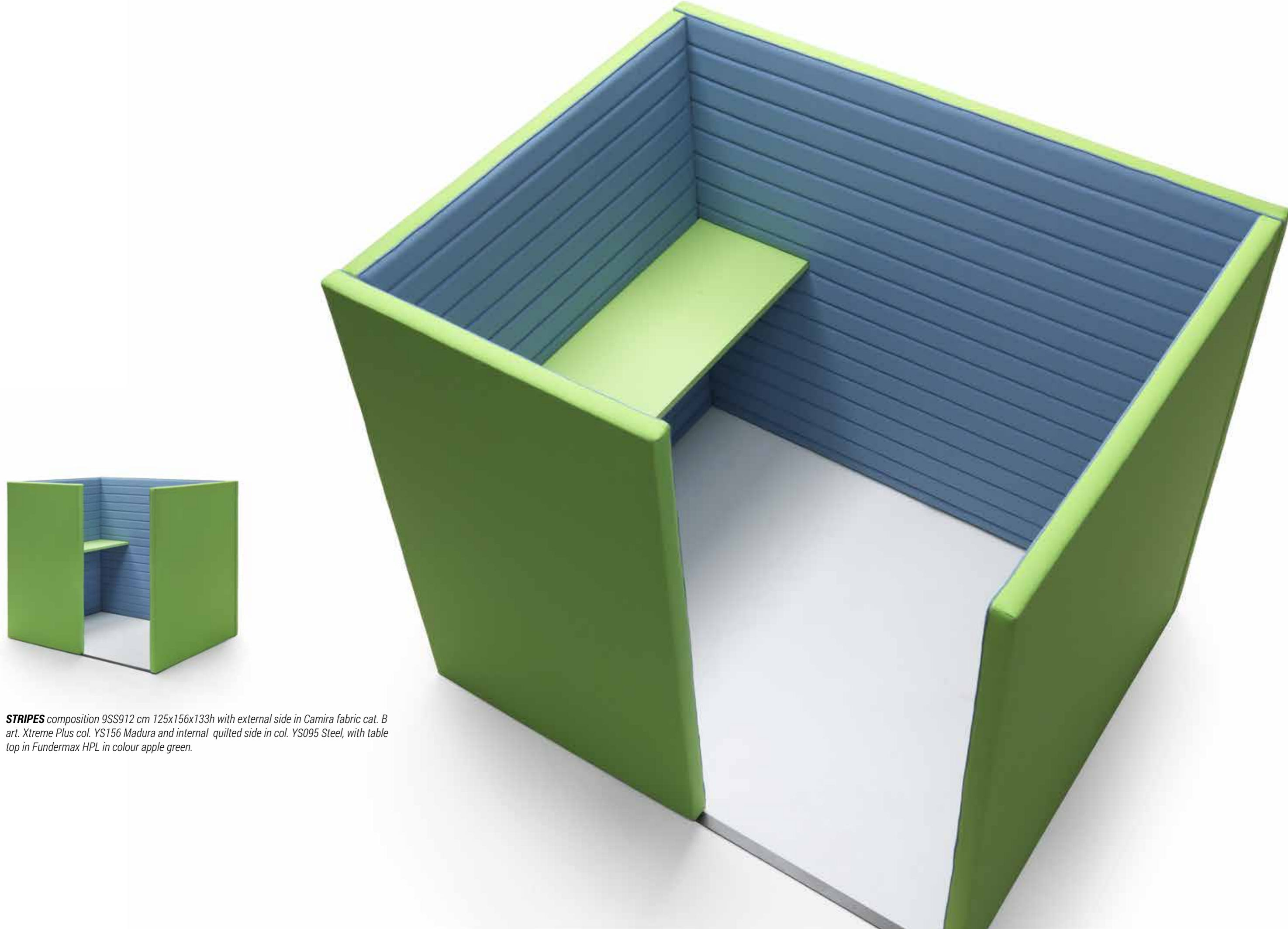

STRIPES composition 9SS912 cm 125x156x133h with external side in Camira fabric cat. B art. Xtreme Plus col. YS156 Madura and internal quilted side in col. YS095 Steel, with table top in Fundermax HPL in colour apple green.

STRIPES element 9SS913 cm 100x73x215h with external side in Camira fabric cat. B art. Xtreme Plus col. YS156 Madura and top and internal quilted side in col. YS095 Steel, with table top in Fundermax HPL in colour apple green and Bachmann Power Frame electric module 9SS803.

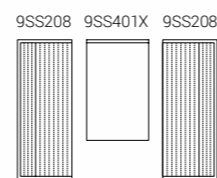

>
STRIPES composition "L" made of 2 sofas 9SS208 cm 185x73x133h with external side in Camira fabric cat. B art. Xtreme Plus col. YS156 Madura and internal quilted side in col. YS095 Steel, with table 9SS401X cm 82x133x133h top in Fundermax HPL in colour apple green and Bachmann Power Frame electric module 9SS803. OPM6 RAL 9017 black painted metal bases.

STRIPES element 9SS915 cm 228x185x133h and 2 elements 9SS914 cm 185x73x133h in the same fabrics.

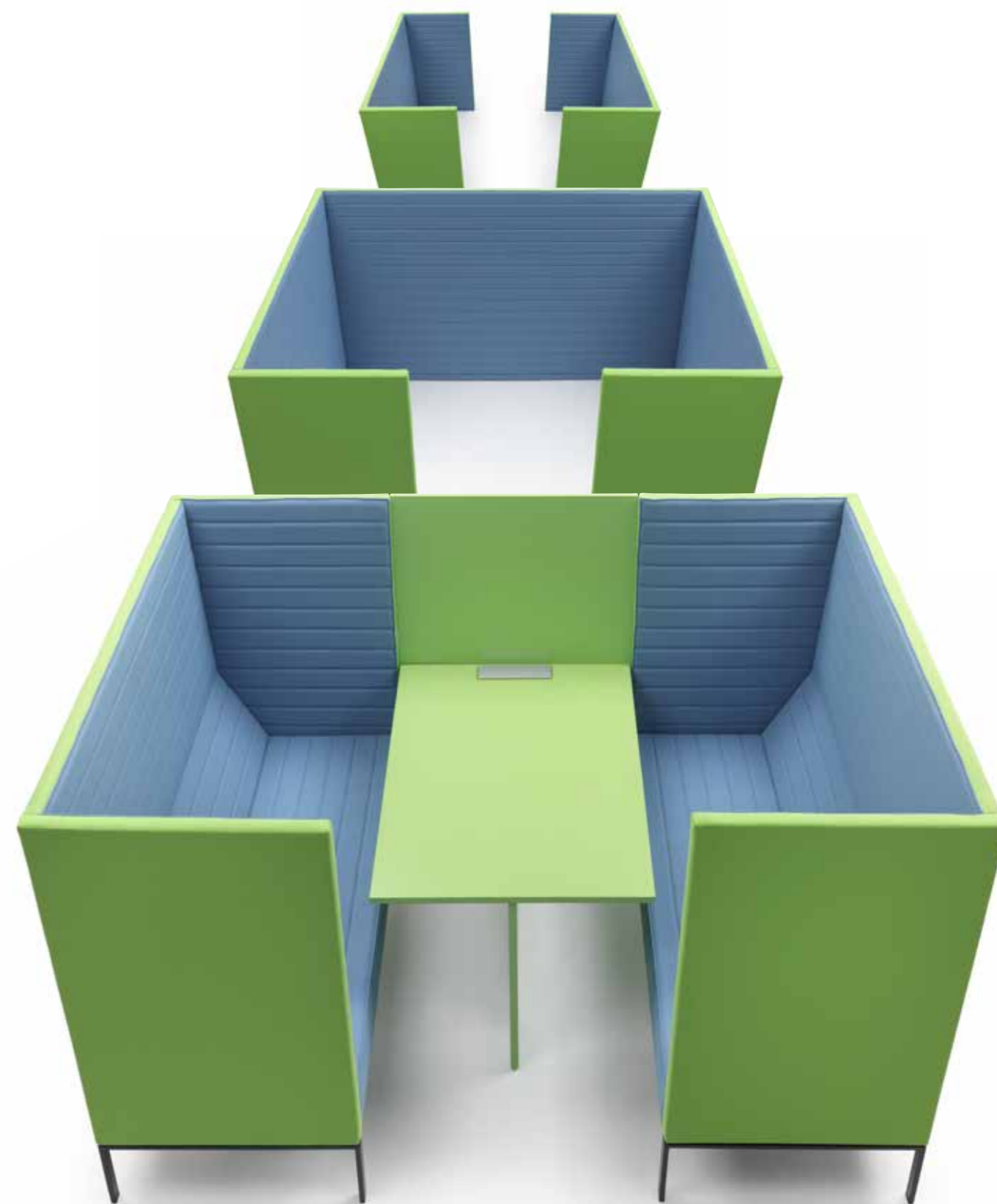



STRIPES armchairs 9SS107 cm 80x73x133h in Camira fabric cat. B art. Xtreme Plus col. Havana YS009 with OPM1 shiny chrome metal bases.



STRIPES swivel armchair 9SS108 cm 80x73x133h in Camira fabric cat. B art. Xtreme Plus col. Havana YS009 with OPM1 shiny chrome metal base.

H-SOFA composition cm 308x462 in Gabriel fabric cat. B art. Atlantic col. 60063 beige with wooden panels and tables in natural oak and OPM6 RAL 9017 black painted metal base. Schulte Evoline sockets 9SS802 and Belux lamps 9SS805. **PIVOT** swivel armchairs 9PIV101 cm 55.5x54x80h with natural oak structure and seat and back in fabric cat. B art. Atlantic col. 60063 beige and 61163 grey and **PIVOT** table 7PIV101 ø cm 60x43/61 in natural oak.

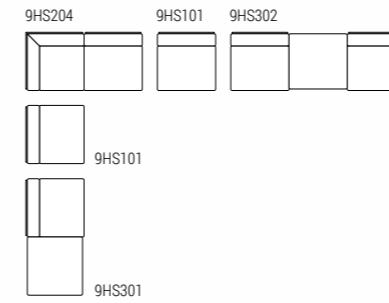

H-SOFA composition cm 308x462 in Gabriel fabric cat. B art. Atlantic col. 60063 beige with wooden panels and tables in natural oak and OPM6 RAL 9017 black painted metal base. Schulte Evoline sockets 9SS802 and Belux lamps 9SS805.

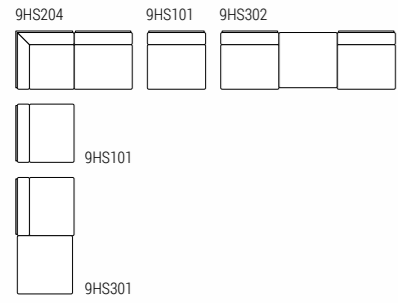

H-SOFA sofa with table 9HF302 cm 231x77x74h in Gabriel fabric cat. B art. Atlantic col. 60063 beige with wooden panels and table in natural oak and OPM6 RAL 9017 black painted metal base. Schulte Evoline sockets 9SS802 and Belux lamp 9SS805.



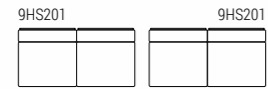

H-SOFA sofa cm 308x77x74h made of 2 elements 9HS201 cm 154x77x74h in Kvadrat fabric cat. H art. Remix 2 col. 933 with natural oak wooden panels and OPM7 RAL 9016 white painted metal base. PIVOT swivel armchair 9PIV101 55.5x54x80h with natural oak structure and seat and back in Gabriel fabric cat. B art. Atlantic col. 61163. PIVOT tables 7PIV101 ø cm 60x43/61 and 7PIV102 ø cm 78x43/74h in natural oak.



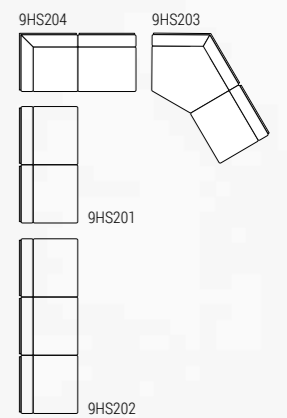

H-SOFA composition cm 344x462 in Kvadrat fabric cat. H art. Remix 2 col. 933 with natural oak panels and OPM7 RAL 9016 white painted metal bases. **PIVOT** swivel armchairs 9PIV101 55.5x54x80h with natural oak structure and seat and back in Gabriel fabric cat. B art. Atlantic col. 61163. **PIVOT** tables 7PIV101 ø cm 60x43/61 and 7PIV102 ø cm 78x43/74h in natural oak.

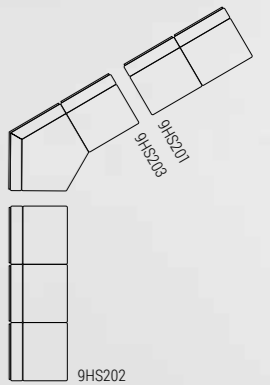

H-SOFA composition cm 308x308 in Gabriel fabric cat. B art. Atlantic col. 61163 with OPM6 RAL 9017 black painted metal base and natural oak panels. **PIVOT** swivel armchairs 9PIV101 cm 55.5x54x80h with natural oak structure and seat and back in fabric cat. B art. Atlantic col. 62048 and **PIVOT** tables 7PIV101 ø cm 60x43/61 and 7PIV102 ø 78x43/78h in natural oak.

H-SOFA composition cm 308x308 in Gabriel fabric cat. B art. Atlantic col. 61163 with OPM6 RAL 9017 black painted metal base and natural oak panels. **PIVOT** swivel armchairs 9PIV101 cm 55.5x54x80h with natural oak structure and seat and back in fabric cat. B art. Atlantic col. 62048 and **PIVOT** tables 7PIV101 ø cm 60x43/61 and 7PIV102 ø 78x43/78h in natural oak.

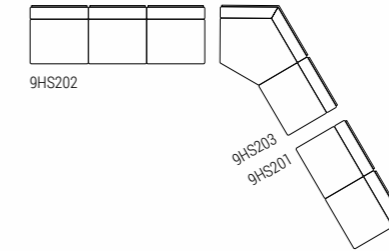

L-SOFA sofa 9LF207 cm 260x78x70h in Gabriel fabric cat. B art. Atlantic col. 61078 with natural oak panels and OPM6 RAL 9017 black painted metal base.



L-SOFA sofas 9LF207 cm 260x78x70h in Gabriel fabric cat. B art. Atlantic col. 61078 with natural oak panels, OPM6 RAL 9017 black painted metal base and cushions 9RL112 cm 63x33 in fabric cat. B art. Atlantic col. 61163. **PIVOT** swivel armchairs 9PIV101 cm 55.5x54x80h with natural oak structure and seat and back in fabric cat. B art. Atlantic col. 60063 and 61163 and **PIVOT** tables 7PIV101 ø cm 60x43/61 and 7PIV102 ø 78x43/78h in natural oak.



L-SOFA composition cm 220x280 and small cushions 9RL112 cm 63x33 in Kvadrat fabric cat.G art. Field col. 242 with natural oak panels and OPM2 matt brushed metal bases. **L-SOFA** table 7LF102 cm 108x108x23h with OPM2 matt brushed metal base and natural oak top.

9LF202

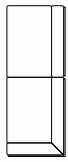
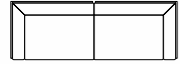

9LF204



L-SOFA sofa 9LF202 cm 220x78x70h in Kvadrat fabric cat. H art. Tonus col. 613 with RAL 7003 painted oak panels and OPM2 matt brushed metal bases.



L-SOFA element 9LF104 cm 92x78x70h and pouf 9LF105 cm 92x92x42h in Kvadrat fabric cat. H art. Tonus col. 940 with OPM2 matt brushed metal bases.



L-SOFA sofa without armrests 9LF206 cm 184x78x70h and sofa 9LF202 cm 220x78x70h in Kvadrat fabric cat. H art. Tonus col. 613 with RAL 7003 painted panels and OPM2 matt brushed metal bases.





L-SOFA element 9LF208 cm 276x78x70h in fabric cat. H art. Steelcut Trio col. 453 with natural oak top and OPM6 RAL 9017 black painted metal bases. Belux Lamp 9SS805 and Schulte Evoline sockets 9SS802.

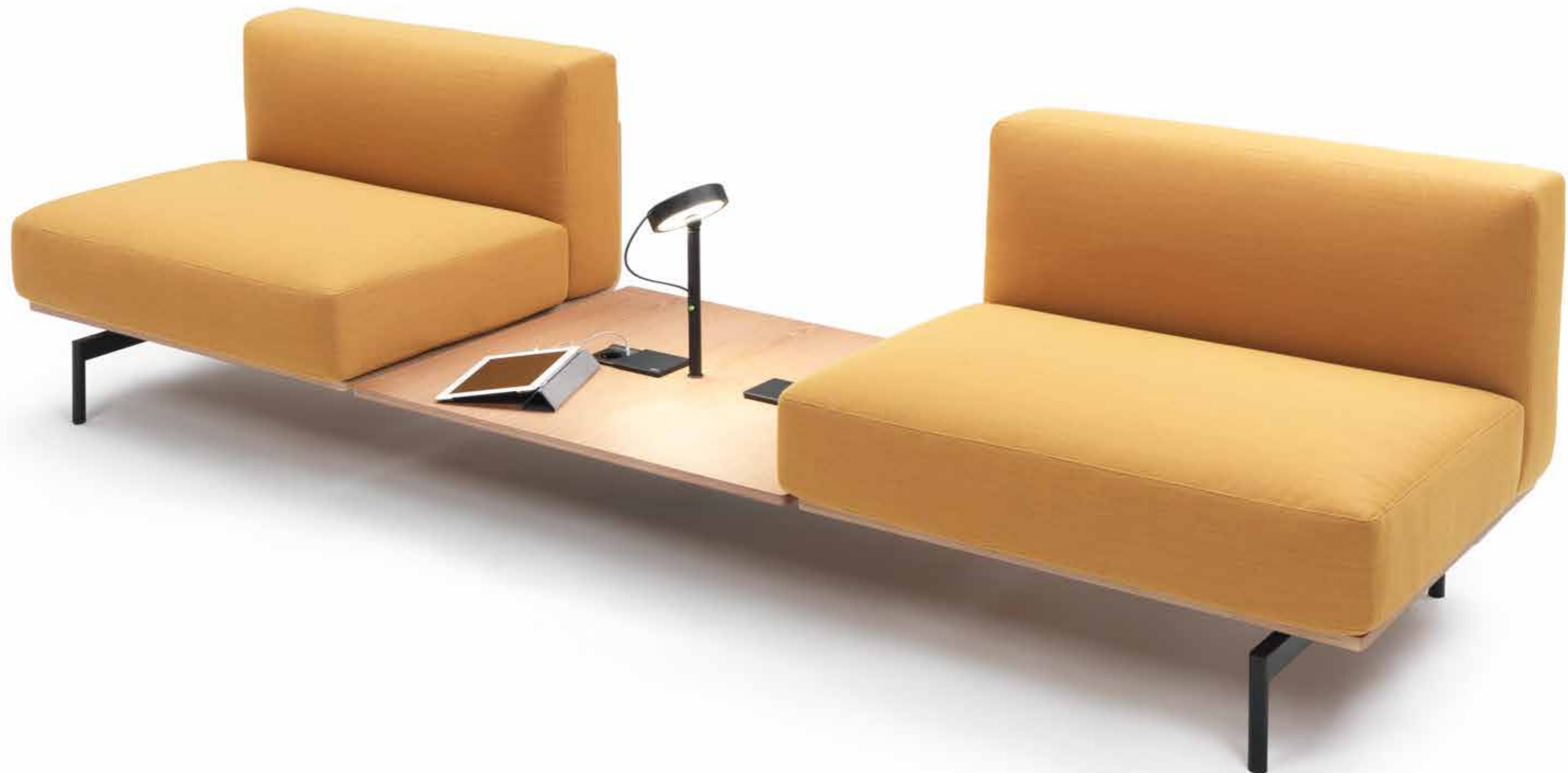
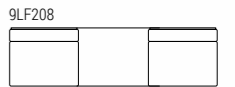



L-SOFA armchair 9LF102 cm 128x78x70h in leather cat. Super art. Dollaro col. 7110 with RAL 7016 painted oak panels and OPM2 matt brushed metal base.



PIVOT swivel armchair 9PIV101 cm 55.5x54x80h with natural oak structure and seat and back in Camira fabric art. Xtreme Plus col. Sombrero YS046.



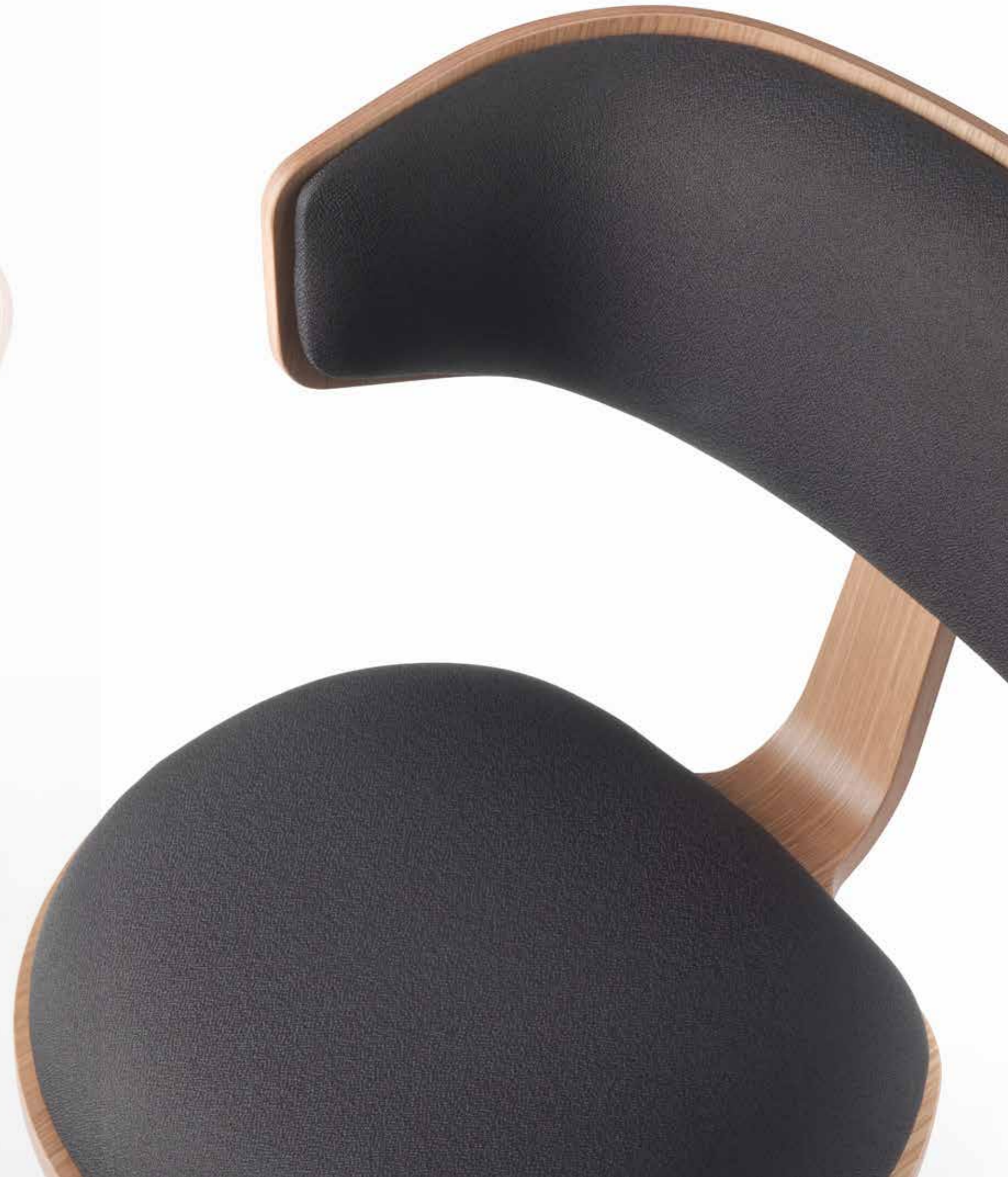

PIVOT swivel armchair 9PIV101 cm 55.5x54x80h with natural oak structure and seat and back in Camira fabric art. Xtreme Plus col. Sombrero YS046.

PIVOT swivel armchairs 9PIV101 cm 55.5x54x80h with natural oak structure and seat and back in Camira fabric cat. B art. Xtreme Plus col. Sombrero YS046 and with RAL 9017 black painted oak structure and seat and back in fabric cat. B art. Xtreme Plus col. Krabi YS141.
PIVOT tables 7PIV101 ø cm 60x43/61 and 7PIV102 ø cm 78x43/74h in natural oak.





PIVOT tables 7PIV101 ø cm 60x43/61 and
7PIV102 ø cm 78x43/74h in natural oak.



Stripes

Design Jérôme Gauthier 2009

Available widths

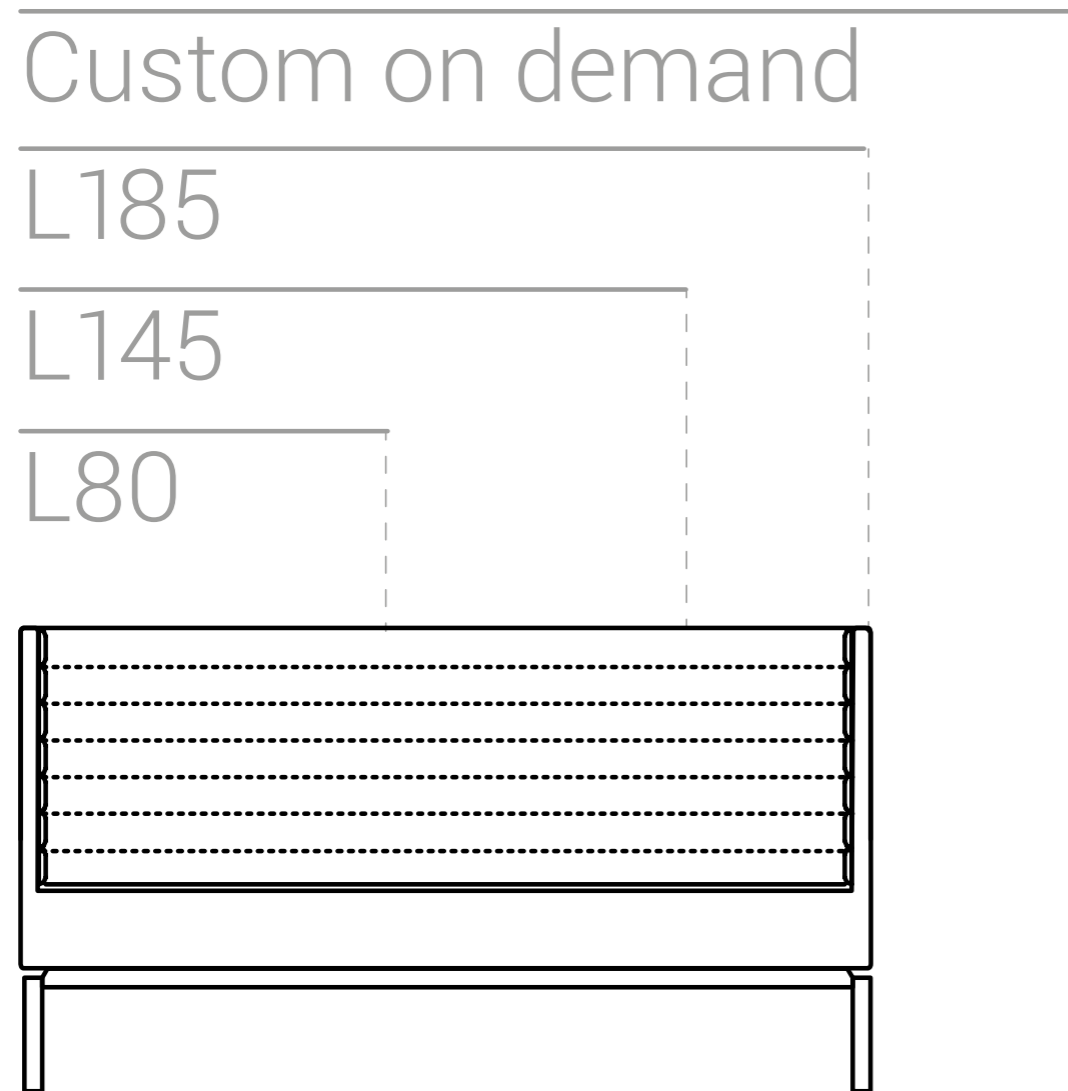

Stripes

Design Jérôme Gauthier 2009

Available heights

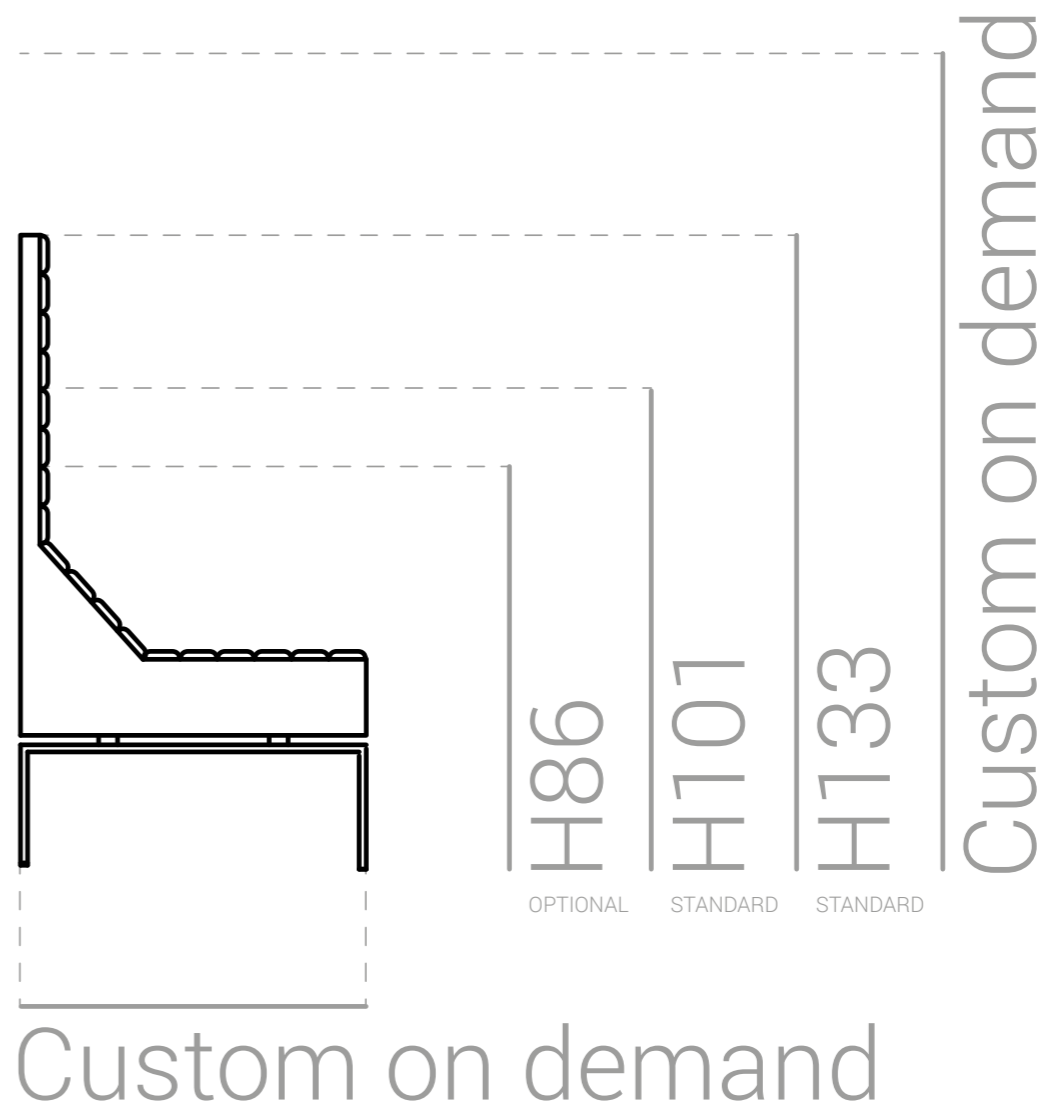

Stripes

Design Jérôme Gauthier 2009

Sofas

H101

9SS112
L80 P73 H101

9SS114
L120 P73 H101

9SS113
L80 P73 H101
Swivel armchair

9SS505
L73 P73 H101
Corner element

9SS201
L145 P73 H101

9SS202
L145 P73 H101

9SS204
L145 P73 H101

9SS209
L185 P73 H101

9SS210
L185 P73 H101

9SS212
L185 P73 H101

H133

9SS107
L80 P73 H133

9SS304
L120 P73 H133

9SS108
L80 P73 H133
Swivel armchair

9SS401
L73 P73 H133
Corner element

9SS301
L145 P73 H133

9SS303
L145 P73 H133

9SS305
L145 P73 H133

9SS205
L185 P73 H133

9SS207
L185 P73 H133

9SS208
L185 P73 H133

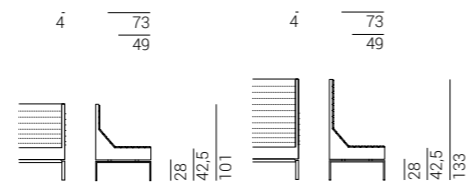

Stripes

Design Jérôme Gauthier 2009

Accessories

9RL112
L63 H33
Feather cushion without band

9SS101
L145 P73 H42,5

9SS103
L185 P73 H42,5

9SS102
L60 P30 H62
Horizontally adjustable server with metal top

9SS104
L73 P73 H37
Small table with transparent glass top

| | | | | | | | |
|------------------------|------------------------------|------------------------------|------------------------------|----------------------------------|-----------------------------|--------------------------|--------------------------------------|
| | RAL 9017 black painted metal | RAL 9016 White painted metal | Classic bronze painted metal | RAL 9006 Aluminium painted metal | | | |
| Code | OPM6 | OPM7 | OPM9 | | | | |
| Standard base finishes | ● | ● | ● | ● | | | |
| | Shiny chrome metal | Brushed matt chrome metal | Brushed matt dark grey metal | Brushed copper metal | Brushed antique brass metal | Shiny black chrome metal | Brushed antique gold metal |
| Code | OPM1 | OPM2 | OPM3 | OPM12 | OPM13 | OPM14 | OPM15 |
| Optional base finishes | ● | ● | ● | ● | ● | ● | ● |
| | | | | | | | Metal painted in RAL Classic colours |

Stripes

Design Jérôme Gauthier 2009

Tables
25 mm thick

Tables

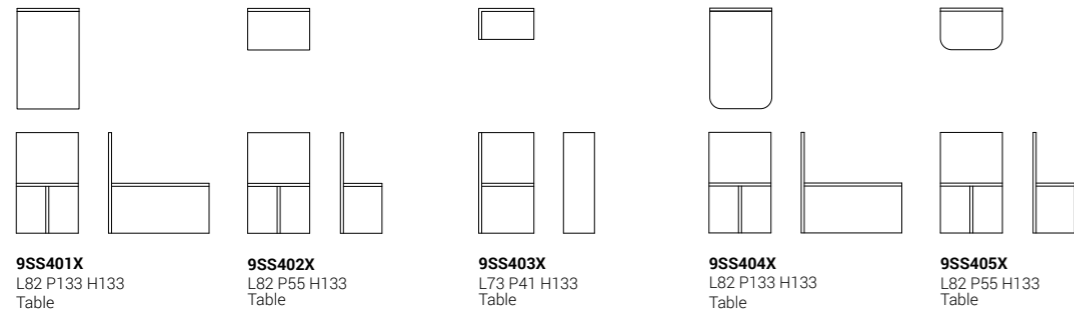

9SS401X
L82 P133 H133
Table

9SS402X
L82 P55 H133
Table

9SS403X
L73 P41 H133
Table

9SS404X
L82 P133 H133
Table

9SS405X
L82 P55 H133
Table

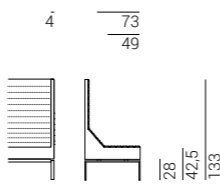

| | | | |
|-----------------------|---------------------|----------------|---------------------------------------|
| Table finishes | Melamine (standard) | HPL (optional) | Birch plywood oak veneered (optional) |
| | ● | ● | ● |

Stripes

Design Jérôme Gauthier 2009

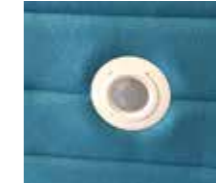

* Activation of led lighting through motion detector (standard version) or, on demand, by means of a switch.

Box

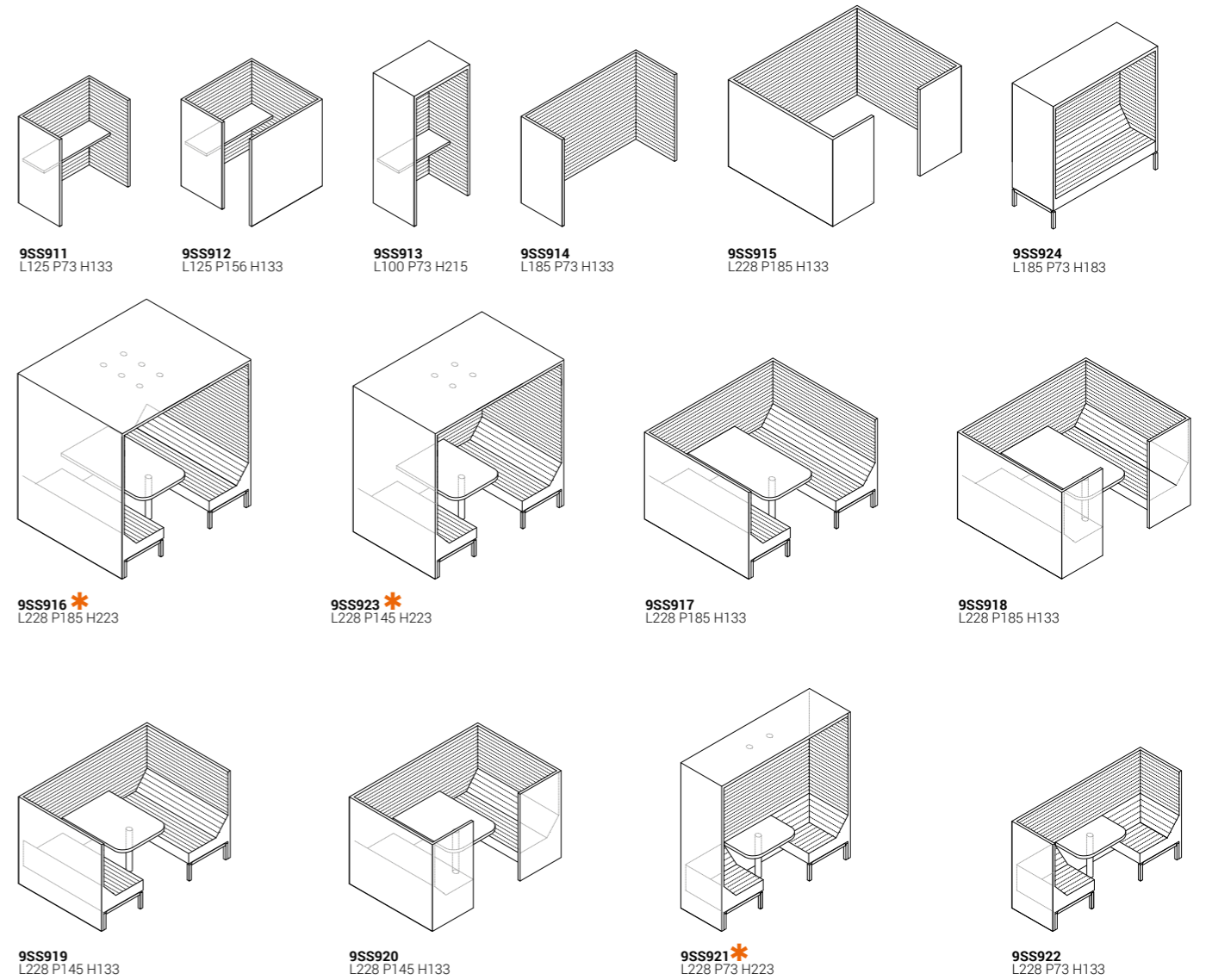

9SS911
L125 P73 H133

9SS912
L125 P156 H133

9SS913
L100 P73 H215

9SS914
L185 P73 H133

9SS915
L228 P185 H133

9SS924
L185 P73 H183

9SS916 *
L228 P185 H223

9SS923 *
L228 P145 H223

9SS917
L228 P185 H133

9SS918
L228 P185 H133

9SS919
L228 P145 H133

9SS920
L228 P145 H133

9SS921 *
L228 P73 H223

9SS922
L228 P73 H133

Configuration for wall screen available on demand.

| | | | | |
|------------------------|---|---|---|---|
| Code | RAL 9017 black painted metal OPM6 | RAL 9016 White painted metal OPM7 | Classic bronze painted metal OPM9 | RAL 9006 Aluminium painted metal |
| Standard base finishes | ● | ● | ● | ● |
| Code | Shiny chrome metal OPM1 | Brushed matt chrome metal OPM2 | Brushed matt dark grey metal OPM3 | Brushed copper metal OPM12 |
| Optional base finishes | ● | ● | ● | ● |
| | | | | Brushed antique brass metal OPM13 |
| | | | | Shiny black chrome metal OPM14 |
| | | | | Brushed antique gold metal OPM15 |
| | | | | Metal painted in RAL Classic colours |

Stripes

Design **Jérôme Gauthier** 2009

Optionals



9SS801 *
L11 P5 H31
Bachmann power frame mobile module



9SS802 **
L10 H10
Schulte Evoline



9SS803 *
L26 x H9
Bachmann power frame module



9SS804
L27 P16 H7,5 (totaleH24)
Mobile lamp



9SS805
ø14 H32
Beluxe lamp



9SS806
L42 P20 H24
Mobile shelf

Stripes

Design **Jérôme Gauthier** 2009

Optionals



9SS807 *
L24 x H7,5
Bachmann power frame module



9SS808
P36 H115
High shelf for sofas



9SS809
P36 H77
Low shelf for sofas

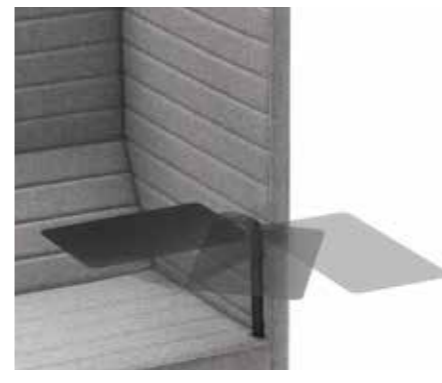

9SS810
L25 P40
Mobile writing shelf

The Bachmann Power Frame electric module is available in the standard version with 2 Schuko and 2 USB sockets, in accordance with the European standards; on demand, it is also available according to the Swiss or European standards or it can be customized with different combinations of internal modules with a price increase.

The standard kit is available with 1 Schuko, 1 USB and 1 RJ45 socket, exclusively according to the European standards.

Stripes

Design Jérôme Gauthier 2009

*Other colours
available on demand*

Tables finishes
HPL samples



0001

0561

0593

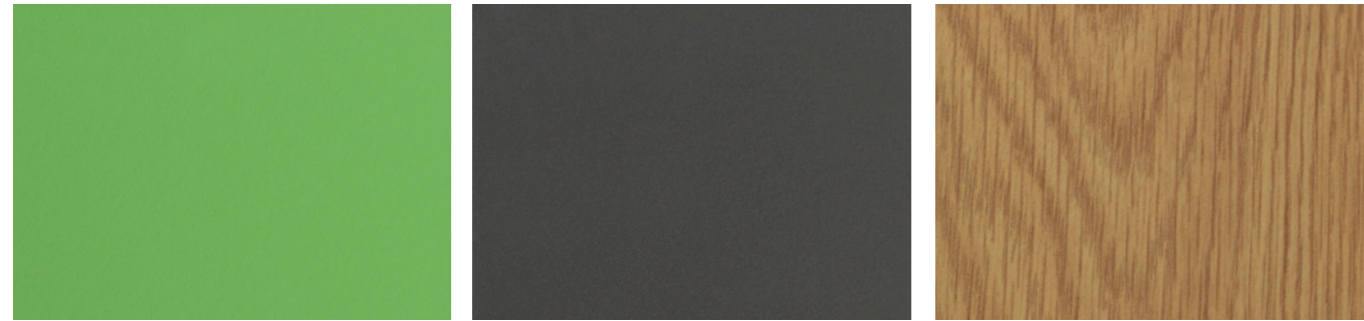

0606

0706

1661



4511

4513

4517

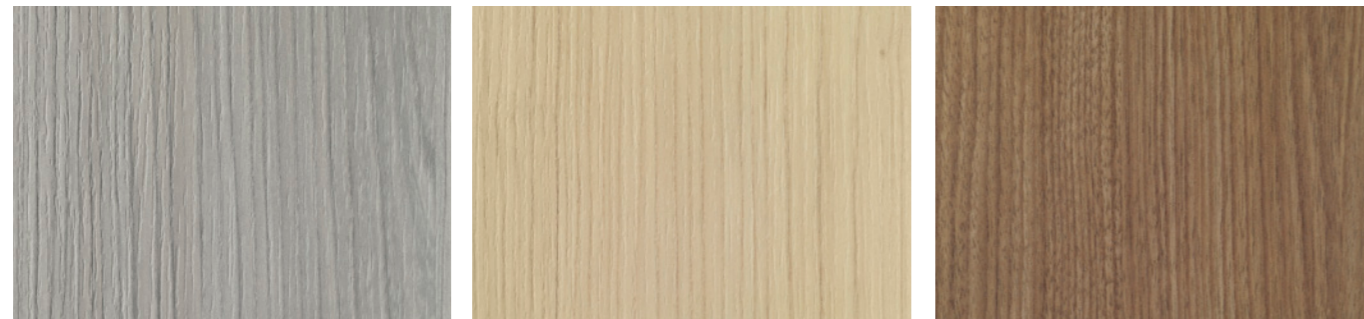

4528

4529

4537

Stripes

Design Jérôme Gauthier 2009

Tables finishes
Oak samples

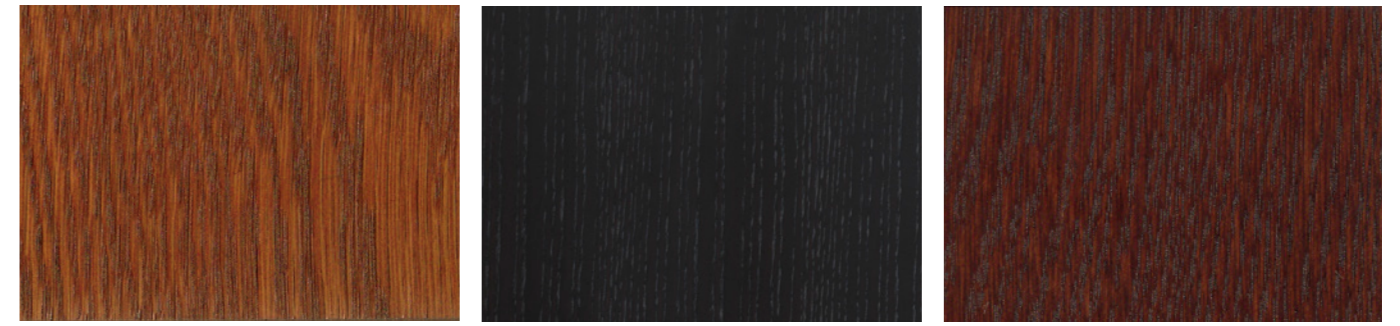

OPR1
Cherry stained oak

OPR2
Wengé stained oak

OPR3
Walnut stained oak

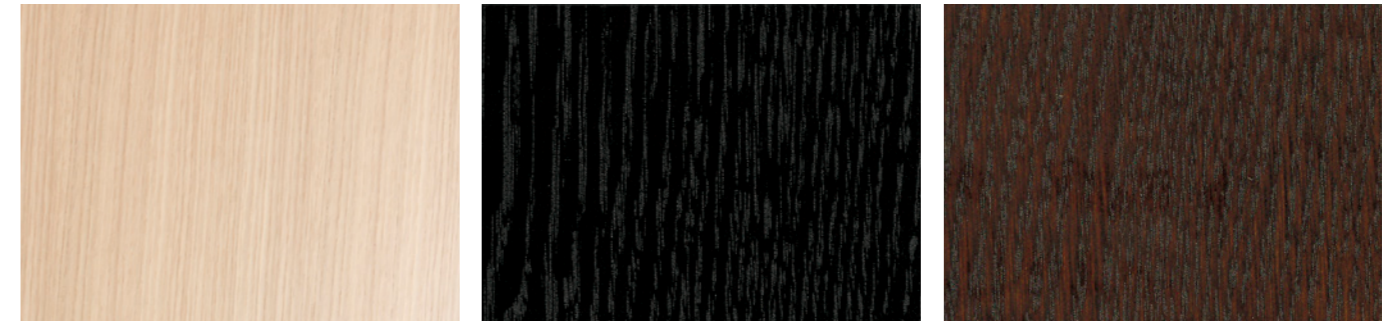

OPR4
Natural oak

OPR5
Black stained oak

OPR6
Cherry Milano stained oak

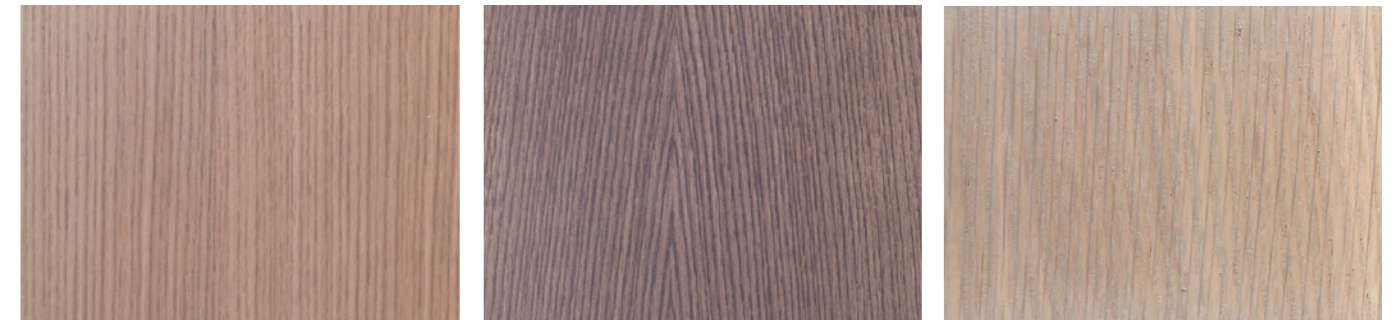

OPR8
Tobacco stained oak

OPR9
Grey taupe stained oak

OPR10
Whitened oak

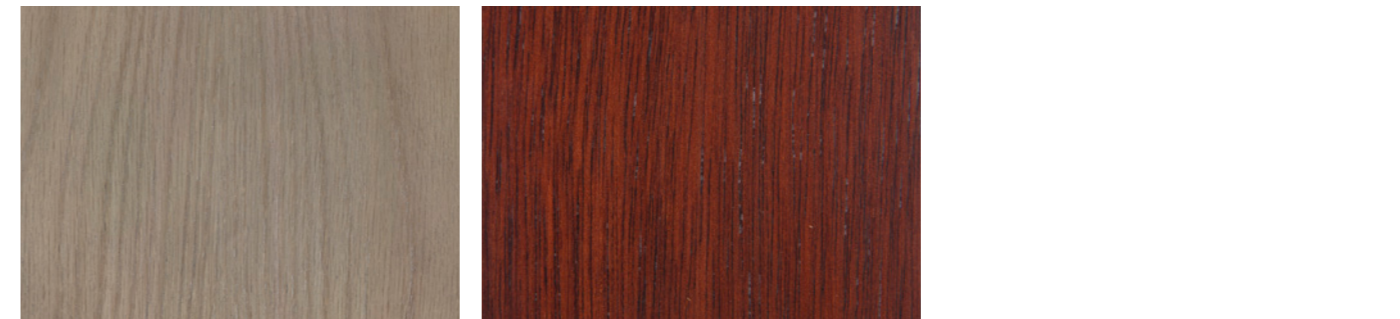

OPR11
Charcoal stained oak

OPR12
Mahogany stained oak

Stripes

Design Jérôme Gauthier 2009

Tables finishes
Melamine samples



Whitened oak

Taupe oak

Tabacco oak

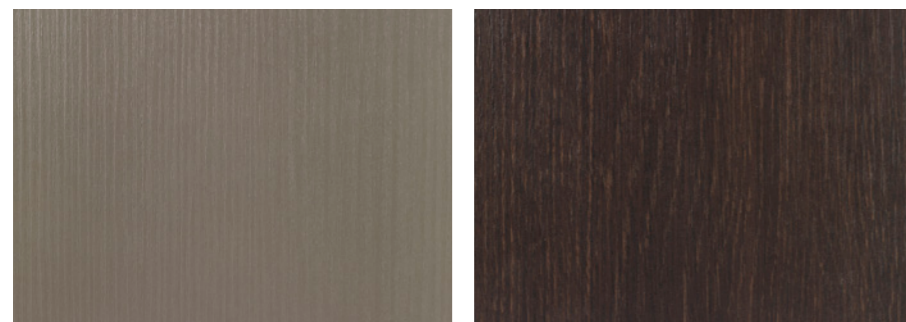

Grey oak

Wengé oak



White

Whitened

Grey

Stripes

Design Jérôme Gauthier 2009

Metal finishes



OPM1
Shiny chrome metal

OPM2
Brushed matt chrome metal

OPM3
Brushed matt dark grey metal



OPM6
RAL 9017 black painted metal

OPM7
RAL 9016 white painted metal

OPM9
Classic bronze painted metal



OPM12
Brushed copper metal

OPM13
Brushed antique brass metal

OPM14
Shiny black chrome metal



OPM15
Brushed antique gold metal

RAL 9006
Aluminium painted metal

Metal painted
in RAL Classic colours

Stripes

Design Jérôme Gauthier 2009

Compositions

COMPOSITION A

Pagg. 10-11-12-13-14-15

9SS604 x4
Sofa
9SS809 x2
Low shelf

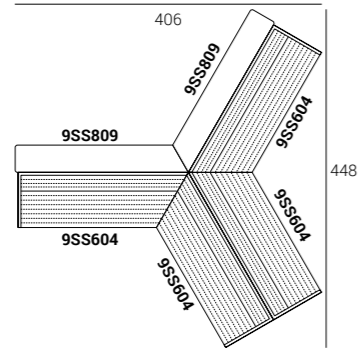

COMPOSITION B

Pagg. 20-21-22-23

9SS908 x2
Sofa
9SS907
Sofa

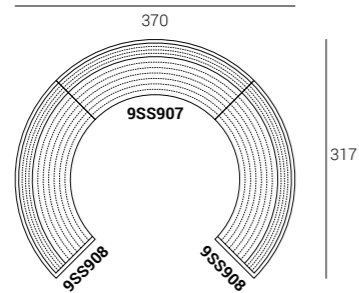

COMPOSITION C with high shelf

Pagg. 24-25-26-27

9SS208 x2
Sofa
9SS808
High shelf
9SS404X
Table

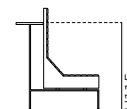
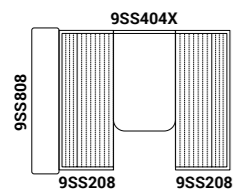

COMPOSITION C with low shelf

Pagg. 24-25-26-27

9SS208 x2
Sofa
9SS809
Low shelf
9SS404X
Table

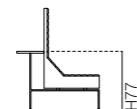
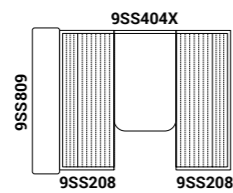

Stripes

Design Jérôme Gauthier 2009

Compositions

COMPOSITION D

Pagg. 32-33-34-35

9SS210 x2
Sofa
9SS809 x2
Low shelf

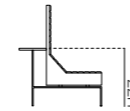
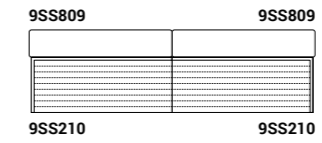

COMPOSITION E

Pagg. 36-37

9SS401 x2
Sofa
9SS405X
Table

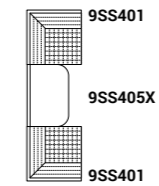

COMPOSITION F

Pagg. 36-37

9SS610 x2
Sofa
9SS808
High shelf

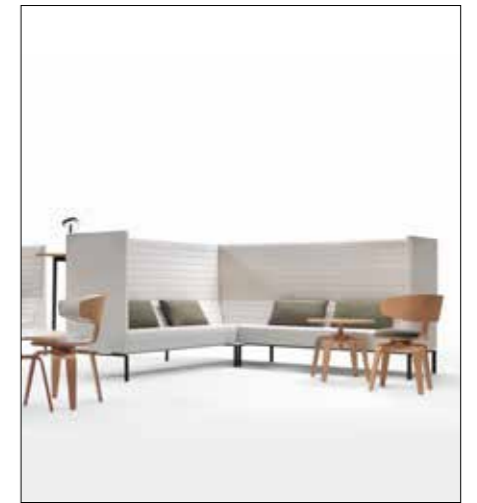
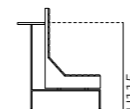
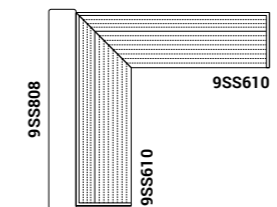

Stripes

Design Jérôme Gauthier 2009

Compositions

COMPOSITION G

Pagg. 42-43

- 9SS401**
Sofa
- 9SS403X**
Table

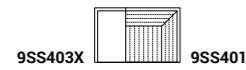

COMPOSITION H

Pagg. 42-43

- 9SS401** x2
Sofa
- 9SS402X**
Table

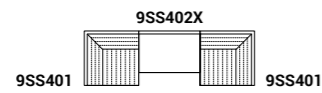

COMPOSITION J

Pagg. 50-51-52-53

- 9SS614** x2
Sofa
- 9SS615** x1
Sofa
- 9SS908** x3
Low shelf

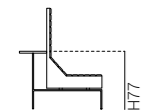
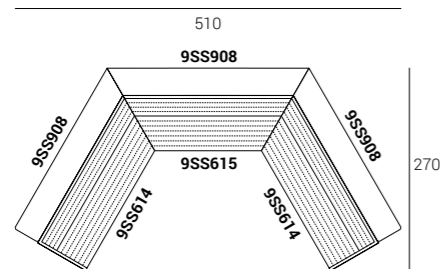

Stripes

Design Jérôme Gauthier 2009

Compositions

COMPOSITION K

Pagg. 54-55-56-57

- 9SS907**
Sofa
- 9SS906**
Sofa
- 9SS909**
Sofa
- 9SS207**
Sofa
- 9SS805**
Low shelf

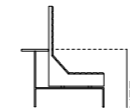
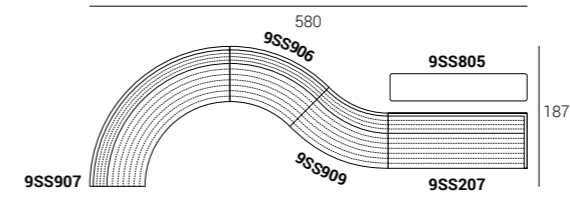

COMPOSITION L

Pagg. 64-65

- 9SS208** x2
Sofa
- 9SS401X**
Table

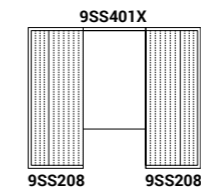

Stripes

Design **Jérôme Gauthier** 2009

Stripes, a collection of park benches

Stripes, a collection of park benches

Stripes, a collection of park benches

Stripes, a collection of park benches

Stripes, a collection of park benches

Stripes, a collection of park benches

Stripes, a collection of park benches

Stripes, a collection of park benches

Stripes, a collection of park benches

Stripes, a collection of park benches

Stripes, a collection of park benches

Stripes, a collection of park benches

Stripes, a collection of park benches

Stripes, a collection of park benches

Stripes, a collection of park benches

Stripes, a collection of park benches

Stripes, a collection of park benches

Stripes, a collection of park benches

Stripes, a collection of park benches

Stripes, a collection of park benches

Stripes, a collection of park benches

Stripes, a collection of park benches

Stripes, a collection of park benches

Stripes, a collection of park benches

Stripes, a collection of park benches

Stripes, a collection of park benches

Stripes, a collection of park benches

Stripes, a collection of park benches

Stripes, a collection of park benches

Stripes, a collection of park benches

Stripes, a collection of park benches

Stripes, a collection of park benches

Stripes, a collection of park benches

Stripes, a collection of park benches

Stripes, a collection of park benches

Stripes, a collection of park benches

Stripes, a collection of park benches

Stripes, a collection of park benches

Stripes, a collection of park benches

Stripes, a collection of park benches

Stripes, a collection of park benches

Stripes, a collection of park benches

Stripes, a collection of park benches

Stripes, a collection of park benches

Stripes, a collection of park benches

Stripes, a collection of park benches

Stripes, a collection of park benches

Stripes, a collection of park benches

Stripes, a collection of park benches

Stripes, a collection of park benches

Stripes, a collection of park benches

Stripes, a collection of park benches

Stripes, a collection of park benches

Stripes, a collection of park benches

Stripes, a collection of park benches

Stripes, a collection of park benches

Stripes, a collection of park benches

Stripes, a collection of park benches

Stripes, a collection of park benches

Stripes, a collection of park benches

Stripes, a collection of park benches

Stripes, a collection of park benches

Stripes, a collection of park benches

Stripes, a collection of park benches

Stripes, a collection of park benches

Stripes, a collection of park benches

Stripes, a collection of park benches

Stripes, a collection of park benches

The STRIPES collection, created by the designer Jérôme Gauthier, was inspired by the typical wooden horizontal slat benches used in public parks in Paris and is characterized by the stripes quilting, that is where the name "Stripes" comes from.

Stripes is a tested sound absorbing model and complies with the U.S. BIFMA standards.

In order to enhance the ergonomics and the comfort of the product, the backrest is equipped with a low back support with an inclination angle of about 22 degrees, so that no further cushions are needed to ensure the sofa comfort.

Seat, backrest and arms have a frame made of 20 and 40 mm multi-ply wooden panels of the highest quality. The frame resistance is guaranteed by a joint construction.

The seat, which is not equipped with interwoven elastic belts, is made of polyurethane foam CM 40/P kg/m³ 5,9 kPa, with supports in foam SR75 Kg/m³ 15,5 kPa. Backrest and low back support are made of polyurethane foam CM 40 kg/m³ 5,9 kPa.

Frame and arms are upholstered with polyurethane foam with a density of 40 kg/m³ 5,9 kPa and 75 kg/m³ 15,5 kPa. The presence of polyurethane aggregates with an overall density of 200 kg/m³, under which there is a 40 x 5 mm metal plate, ensure the product durability over time in the areas which are more subject to deformation. The external frame side is also lined with a 250 gr. thermo-bonded fibre.

The arms are fixed by means of bolts and bajonet joints. The polyurethane foam is always CMHR fire-retardant (Combustion Modified High Resilient) according to the British Standard regulations (BS), Cal 117, Class 11M, or, on demand, according to other regulations (such as the German DIN or the NF French regulations).

The typical stripes, which can be horizontal or vertical, are obtained through a quilting process which couples not only the cover material – fabric, artificial leather or leather, wich dacron, but also a 1 cm thick foam layer. Each stripe is 8 cm high.

Fabric, artificial leather and leather covers are always fixed.

Die Kollektion STRIPES, gezeichnet vom Designer Jérôme Gauthier, lehnt sich an die typischen Fassdaubenbänken in den Pariser Parks und ist durch die Streifenabsteppung – daher der Name « Stripes », gekennzeichnet.

Stripes ist ein schallabsorbierendes, getestetes Modell und besteht die US-BIFMA Tests.

Die Ergonomie und der Sitzkomfort des Produkts werden durch die in der Rückenlehne eingearbeitete Nierenschütze gefördert. Diese hat eine Neigung von ca. 22°, so dass zusätzliche Kissen nicht benötigt werden, um die Bequemlichkeit und den Sitzkomfort dieses Produkts zu gewährleisten.

Sitz, Rückenlehne und Seitenteile bestehen aus einem Gestell aus Schichtholzplatten mit einer Dicke von 20 und 40 mm von höchster Qualität.

Die Haltbarkeit des Gestells wird durch eine Steckkonstruktion gewährleistet.

Die Sitzfläche, ohne geflochtene Gummigürtung, besteht aus Polyurethan-Schaumstoff CM 40/P kg/m³ 5,9 kPa, mit Verstärkung in SR75 Kg/m³ 15,5 kPa.

Rückenlehne und Nierenschütze sind mit Polyurethan-Schaumstoff CM 40 kg/m³ 5,9 kPa gepolstert.

Gestell und Seitenteile sind mit Polyurethan-Schaumstoff mit einer Dicke von 40 kg/m³ 5,9 kPa und 75 kg/m³ 15,5 kPa gepolstert.

Die Verwendung von Polyurethan-Schaumstoff-Aggregaten mit einer Gesamtdichte von 200 Kg/m³ in den Punkten, die der Verformung mehr ausgesetzt sind, sichert die Dauerhaftigkeit des Produktes für lange Zeit. Darunter wird zusätzlich eine Metallplatte 40 x 5 mm befestigt.

Die Aussenseiten des Gestells sind zusätzlich mit einer Ummantelung aus thermogebundenen Fasern mit Gewicht 250 Gr. ausgestattet.

Die Seitenteile sind mittels Schrauben und Bajonetverschlüssen befestigt.

Der Polyurethan-Schaumstoff ist immer schwerentflammbar CMHR (Combustion Modified High Resilient), gemäß British Standard (BS), Cal 117, Klasse 11M, oder, auf Anfrage, gemäß anderen Standards, wie beispielsweise den deutschen DIN-Normen oder den französischen NF-Normen.

Die typischen Streifen – Stripes –, die horizontal oder vertikal ausgeführt werden können, erhält man nicht nur durch die Verbindung des Bezugsmaterials – Stoff, Leder oder Kunstleder – mit Dacron, sondern es wird hier auch Schaumstoff mit einer Dicke von 1 cm eingearbeitet. Jeder Streifen ist 8 cm hoch.

Die Modelle der Serie Stripes sind immer festbezogen.

Stripes

Design **Jérôme Gauthier** 2009

Stripes, a collection of park benches

Stripes, a collection of park benches

Stripes, a collection of park benches

Stripes, a collection of park benches

Stripes, a collection of park benches

Stripes, a collection of park benches

Stripes, a collection of park benches

Stripes, a collection of park benches

Stripes, a collection of park benches

Stripes, a collection of park benches

Stripes, a collection of park benches

Stripes, a collection of park benches

Stripes, a collection of park benches

Stripes, a collection of park benches

Stripes, a collection of park benches

Stripes, a collection of park benches

Stripes, a collection of park benches

Stripes, a collection of park benches

Stripes, a collection of park benches

Stripes, a collection of park benches

Stripes, a collection of park benches

Stripes, a collection of park benches

Stripes, a collection of park benches

Stripes, a collection of park benches

Stripes, a collection of park benches

Stripes, a collection of park benches

Stripes, a collection of park benches

Stripes, a collection of park benches

Stripes, a collection of park benches

Stripes, a collection of park benches

Stripes, a collection of park benches

Stripes, a collection of park benches

Stripes, a collection of park benches

Stripes, a collection of park benches

Stripes, a collection of park benches

Stripes, a collection of park benches

Stripes, a collection of park benches

Stripes, a collection of park benches

Stripes, a collection of park benches

Stripes, a collection of park benches

Stripes, a collection of park benches

Stripes, a collection of park benches

Stripes, a collection of park benches

Stripes, a collection of park benches

Stripes, a collection of park benches

Stripes, a collection of park benches

Stripes, a collection of park benches

Stripes, a collection of park benches

Stripes, a collection of park benches

Stripes, a collection of park benches

Stripes, a collection of park benches

Stripes, a collection of park benches

Stripes, a collection of park benches

Stripes, a collection of park benches

Stripes, a collection of park benches

Stripes, a collection of park benches

Stripes, a collection of park benches

Stripes, a collection of park benches

Stripes, a collection of park benches

Stripes, a collection of park benches

Stripes, a collection of park benches

Stripes, a collection of park benches

Stripes, a collection of park benches

Stripes, a collection of park benches

Stripes, a collection of park benches

Stripes, a collection of park benches

Stripes, a collection of park benches

Stripes, a collection of park benches

De collectie STRIPES, gecreëerd door ontwerper Jérôme Gauthier, is geïnspireerd op de typische bankjes met horizontale houten latten die men in de Parijse openbare parken vindt en wordt gekenmerkt door de doorstikking in streepvorm (vandaar de naam "Stripes").

Stripes is een model dat getest is op zijn geluidsabsorberendheid en is conform aan de BIFMA-tests uit de Verenigde Staten.

Om de ergonomie en het comfort van het product te bevorderen, is de rugleuning voorzien van een lendensteun met een hellingshoek van ca. 22°, zodat geen lendenkussentjes nodig zijn om het comfort te waarborgen.

Zit, rug en arMLEUNINGEN bestaan uit een romp van eerste keus multiplexpanelen van 20 en 40 mm. De stevigheid van de romp wordt gewaarborgd door een pen- en gatconstructie die garant staat voor een lange levensduur.

De zit, zonder door elkaar gekruiste elastische banden, is uitgevoerd in polyurethaanschuim van het type CM 40/P kg/m³ 5,9 kPa en verstevigingen in polyurethaanschuiM van het type SR75 kg/m³ 15,5 kPa.

Rug en lendensteun zijn uitgevoerd in polyurethaan-schuim van het type CM 40 kg/m³ 5,9 kPa.

De romp en de arMLEUNINGen zijn bekleed met polyurethaanschuiM met een densiteit van 40 kg/m³ 5,9 kPa en 75 kg/m³ 15,5 kPa.

Om de duurzaamheid van het product op lange termijn te waarborgen, wordt op de plaatsen die het meest onderhevig zijn aan vervorming samengesteld polyurethaanschuiM met een algemene densiteit van 200 kg/m³ gebruikt, waaronder een metalen plaat van 40 x 5 mm gemonteerd wordt.

De buitenkant van de romp wordt daarenboven bekleed met dacron van 250 gram.

De arMLEUNINGen worden bevestigd met behulp van bouten en bajonetten.

Het polyurethaanschuiM is altijd brandvertragend van het type CMHR (Combustion Modified High Resilient) en beantwoordt aan de normen British Standard (BS), Cal 117, Classe 11M, alsook, op aanvraag, aan andere normen (bijvoorbeeld aan de Duitse DIN-normen of aan de Franse NF-normen).

De typische strepen ("stripes" in het Engels), horizontaal of verticaal, worden verkregen door een doorstikking die niet alleen de bekleding (stof, kunstleer of leer) en de dacron, maar ook een laag polyurethaanschuiM met een dikte van 1 cm aan elkaar koppelt. Elke baan is 8 cm hoog. De bekleding van model Stripes is altijd vast, zowel in stof als in kunstleer als in leer.

Отличительной особенностью коллекции STRIPES от французского дизайнера Жерома Готье (Jérôme Gauthier) является наличие характерной стежки в полоску (отсюда и название STRIPES) , а прообразом послужили скамейки на основе горизонтальных деревянных реек - неизменные спутники парижских общественных парков. Артикулы коллекции Stripes прошли испытание на необходимый уровень звукопоглощения и соответствуют американскому стандарту BIFMA (единая база стандартизации по безопасности, долговечности и рабочих функций тестируемого изделия). Для большей эргономичности и удобства нижняя часть спинки, соприкасающаяся с поясницей, имеет угол наклона в 22°, что позволяет обеспечить комфорт, не используя дополнительные подушки. Каркас сиденья, спинки и подлокотников выполнен из панелей «мультистрато» - многослойной фанеры высшего качества толщиной от 20 до 40мм. Прочность каркаса обусловлена его жесткой конструкцией, обеспечивающей повышенные гарантийно-эксплуатационные качества. Наполнение сиденья из вспененного полиуретана CM плотностью 40/P кг/м³ 5,9 кПа со вставками из вспененного полиуретана SR плотностью 75 Кг/м³ 15,5 кПа, без эластичных перекрещивающихся ремней. Наполнение спинки и нижней части спинки, соприкасающейся с поясницей из вспененного полиуретана CM плотностью 40/P кг/м³ 5,9 кПа

Каркас и подлокотники с покрытием из вспененного полиуретана плотностью 40 кг/м³ 5,9 кПа и 75 кг/м³ 15,5 кПа.

Для обеспечения максимально длительного срока эксплуатации на участках, где чаще всего могут возникать деформации используется наполнение из вспененного полиуретана общей плотностью 200 кг/м³ в сочетании с поддерживающей металлической пластиной 40 x 5 мм. Внешняя часть каркаса отделана слоем из термоскрепленного волокна 250г/м³. Крепление подлокотников на болтах и при помощи байонетного соединения.

Высокоупругий трудновоспламеняемый вспененный полиуретан категории CMHR (Combustion Modified High Resilient), соответствует всем необходимым нормам и стандартам (английский British Standard (BS), американский Технический бюллетень 117 (Cal 117), класс эмиссии M1, Немецкий институт по стандартизации (DIN), французский орган по сертификации (NF).

Характерные для данной коллекции вертикальные либо горизонтальные полосы ("stripes" по-английски) получаютя в результате прострочки, которая соединяет не только обивку (ткань, кожа, искусственная или натуральная) и дакрон, но также захватывает и слой полиуретана толщиной 1см, таким образом, каждая полоса имеет высоту 8см.

Все артикулы коллекции STRIPES имеют несъемную обивку, как в ткани, так и в коже, искусственной либо натуральной.

L-Sofa

Design Jérôme Gauthier 2013

Sofas



9LF101
L112 P78 H70

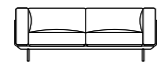

9LF201
L188 P78 H70

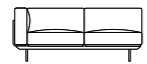

9LF203
L170 P78 H70

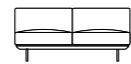

9LF205
L152 P78 H70

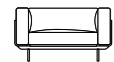

9LF102
L128 P78 H70

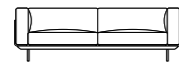

9LF202
L220 P78 H70

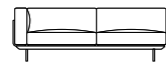

9LF204
L202 P78 H70

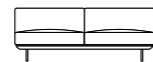

9LF206
L184 P78 H70

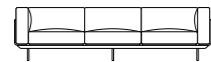

9LF207
L260 P78 H70



9LF103
L110 P78 H70



9LF104
L92 P78 H70

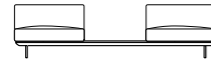

9LF208
L276 P78 H70



9LF107
L94 P78 H70



9LF108
L76 P78 H70

Modular elements

Pouf and accessories



9LF105
L92 P92 H42



9LF106
L108 P108 H42

Cuscinetto in piuma
senza fascia
Feather cushion
without band



9RL112
L63 H33

Top in legno
Wood Top



7LF101
L92 P92 H23



7LF102
L108 P108 H23

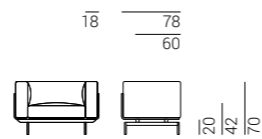

| | Cherry Stained Oak | Wengé Stained Oak | Walnut Stained Oak | Natural Oak | Black Stained Oak | Cherry Milano Stained Oak | Tobacco Stained Oak | Grey taupe Stained Oak | Whitened Oak | Charcoal Stained Oak | Mahogany Stained Oak |
|------------------------|------------------------------------|------------------------------|------------------------------|----------------------------------|-----------------------------|---------------------------|----------------------------|--------------------------------------|--------------|----------------------|----------------------|
| Code | OPR1 | OPR2 | OPR3 | OPR4 | OPR5 | OPR6 | OPR8 | OPR9 | OPR10 | OPR11 | OPR12 |
| Wooden Panels | ● | ● | ● | ● | ● | ● | ● | ● | ● | ● | ● |
| Wooden Panels | Oak Painted in Ral Classic colours | | | | | | | | | | |
| Code | RAL 9017 black painted metal | RAL 9016 White painted metal | Classic bronze painted metal | RAL 9006 Aluminium painted metal | | | | | | | |
| Standard base finishes | ● | ● | ● | ● | ● | ● | ● | ● | ● | ● | ● |
| Code | Shiny chrome metal | Brushed matt chrome metal | Brushed matt dark grey metal | Brushed copper metal | Brushed antique brass metal | Shiny black chrome metal | Brushed antique gold metal | Metal painted in RAL Classic Colours | | | |
| Optional base finishes | ● | ● | ● | ● | ● | ● | ● | ● | ● | ● | ● |

L-Sofa

Design Jérôme Gauthier 2013

Sofa conception



