



GAM
GONZAGARREDI
MONTESSORI

La vecchia scuola in cui i bambini erano educati in modo accademico poteva funzionare con le sedute fisse e le scrivanie avvitate sul pavimento. L'insegnante era di fronte agli alunni e impartiva istruzioni. Ora l'insegnante è diventato un membro di un gruppo attivo che lavora liberamente per la classe, costruisce, cuce, tinge, gestisce tutto il materiale e gli strumenti con i ragazzi ...

The historic school where the children were taught in an academic way managed well with fixed sitting arrangements and with desks screwed to the floor. The teacher faced the pupils and poured instruction into them. Now the teacher has become a member of an active group who works freely around the classroom, constructs, sews, dyes, handles all the materials and equipment with the children ...

Richard Neutra, 1935

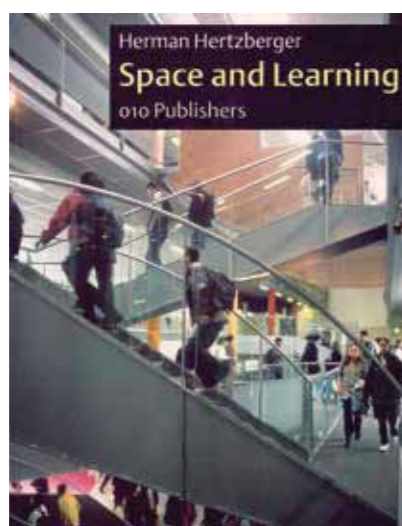
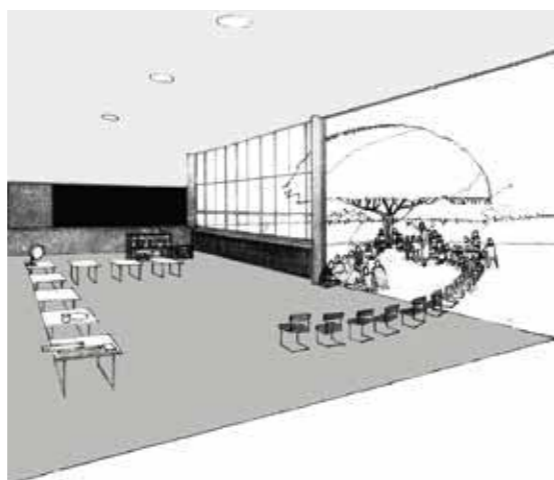

Se è possibile interpretare gli edifici come piccole città, gli edifici scolastici devono essere di gran lunga il miglior esempio. Un'area comune centrale, circondata e modellata da una periferia di entità più ermetiche, le aule, richiama inequivocabilmente l'immagine di uno spazio pubblico di strada o piazza accanto a una zona costruita più privata.

If it is possible to interpret buildings as small cities, then school buildings must be the best example by far. A central common area, surrounded and shaped by a periphery of more hermetic entities, classrooms, unmistakably calls to mind the image of a public space of street or square alongside a more private built zone.

Herman Hertzberger, 2008

La scuola come punto di confluenza della vita culturale di una comunità, nel senso ampio della parola cultura (...) non richiede locali fatti come scatole per immagazzinare ragazzi e insegnanti in classi separate e banchi inchiodati.

The school as a junction point of the cultural life of a community, in the widest sense of the word 'culture' (...) does not require rooms made as if they were boxes in which to store children and teachers in separate classes and desks bolted to the floor.

Tullio De Mauro, 2007



La scuola deve diventare sempre di più una "casa aperta", il centro di una comunità. Con la forza di questa definizione più ampia deve risvegliare e favorire relazioni armoniche e democratiche tra giovani e adulti e contrastare le influenze alienanti della società contemporanea.

The school must become more and more an "open house", a community centre: on the strength of this broader definition, it must strive to awaken and encourage a harmonic, democratic relationship between young and old and to counteract the dehumanizing influences of today's society.

Alfred Roth, 1966



1+4 spazi educativi

1 rappresenta lo spazio di gruppo, l'ambiente di apprendimento polifunzionale del gruppo-classe, l'evoluzione dell'aula tradizionale che si apre alla scuola e al mondo. Un ambiente a spazi flessibili in continuità con gli altri ambienti della scuola.

4 sono gli spazi della scuola complementari, e non più subordinati, agli ambienti della didattica quotidiana. Sono l'Agorà, lo spazio informale, lo spazio individuale e lo spazio esplorazione.

1+4 educational spaces

1 represents the group space, the space for poly-functional learning by the group/class, the evolution of the traditional classroom that opens out to the school and to the world. A space of flexible areas that exist in continuity with the other spaces of the school.

4 represents the spaces of the school that are complementary - and therefore no longer subordinate - to the spaces of everyday teaching, namely the 'Agorà' (central square), the informal space, the individual space and the exploration space.

INDIRE, 2016



L'ambiente è maestro.

(...) L'ambiente deve essere ricco di motivi di interesse che si prestano ad attività e invitano il bambino a condurre le proprie esperienze.

La scuola deve dare una sensazione di benessere ed essere arredata in rispondenza alla concezione di vita libera, individuale e sociale del bambino.

The environment is the guide.

The school environment must abound in sources of interest that allow for activities and invite the child to live its own experience.

The school must give a feeling of well-being and be furnished in accordance with the concept of the child's free, individual and social life.

Maria Montessori



SCUOLA GAM

La scuola che desideriamo offre a studenti e insegnanti
un paesaggio di ambienti per apprendere, insegnare, condividere.
È una rete di spazi flessibili e funzionali.

Si apre al territorio come centro che promuove formazione, cultura, socialità.

GAM SCHOOL

The kind of school we propose offers students and teachers a landscape of spaces for learning, teaching and sharing. It is a network of flexible and functional spaces. It opens up to the local community as a civic centre that promotes education, culture and inclusiveness.

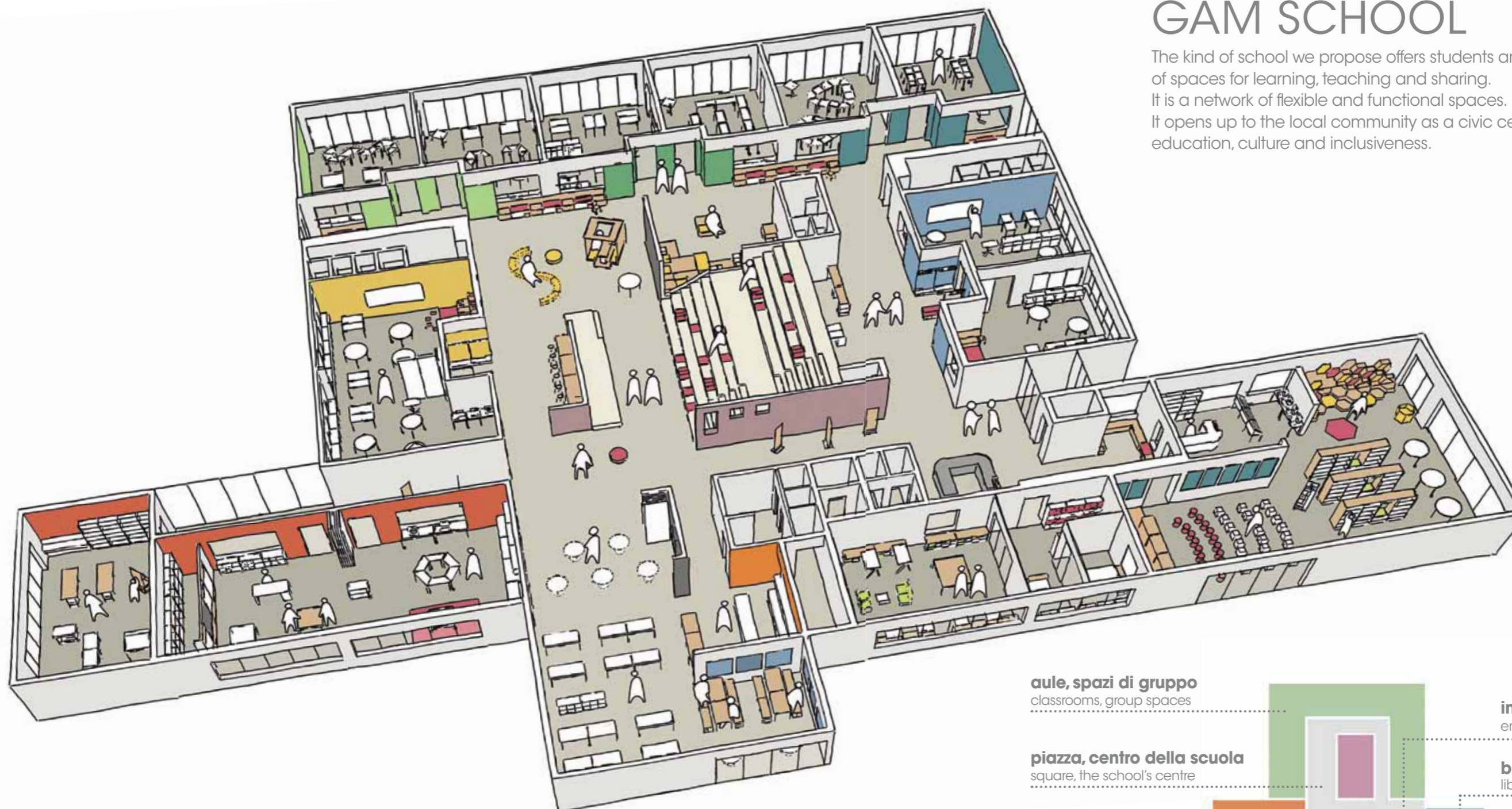

aule, spazi di gruppo
classrooms, group spaces

piazza, centro della scuola
square, the school's centre

laboratori, makerspace, atelier
workshops, makerspaces, ateliers

ingresso, accoglienza
entrance, reception

biblioteca
library

studi dei docenti, segreteria
teachers' spaces, administration office

mensa, spazio polifunzionale
cafeteria, multifunctional space

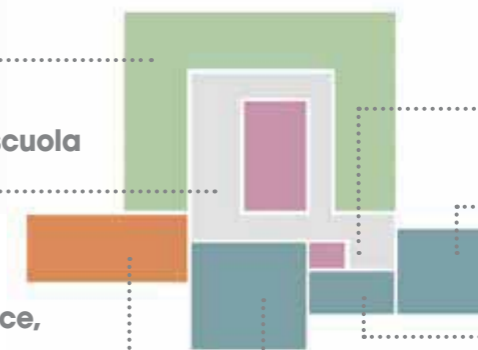



SPAZI COMUNI COMMON SPACES

ingresso, accoglienza 008
entrance, reception

piazza, centro della scuola 010
square, school's centre

**ambienti per incontri,
relax e studio informale** 012
gathering areas,
relaxation and informal studying

disimpegni e spogliatoi 014
passage areas and locker areas

016 sistema per spazi d'ingresso
furnishing for entrance / reception areas

018 pedane, panche, gradoni
stages, benches, risers

022 pannelli, schermi, angoli studio
panels, screens, study corners

024 sedute morbide
soft seating



AULE, SPAZI DI GRUPPO CLASSROOMS, GROUP SPACES

aula policentrica 026
polycentric classroom

aula flessibile 030
flexible classroom

aula cooperativa 034
co-operative classroom

parete presentazioni 036
teaching wall

038 sistema di contenitori
cabinets

056 sistema di tavoli
tables

066 sedie, sgabelli, sedute
chairs, stools, seating

070 sistema parete comunicativa
presentation



SPAZI D'ESPLORAZIONE EXPLORATION SPACES

officine, makerspace 072
workshops, makerspaces

laboratori per nuove tecnologie 074
workshops for new technologies

**atelier, laboratori d'arte
e creatività** 076
ateliers, art and creativity
workshops

078 arredi per spazi di manifattura
furnishing for manufacturing spaces

080 arredi per spazi di sperimentazione
furnishing for experimentation spaces

082 arredi per spazi di creatività
furnishing for creativity spaces

084 arredi per spazi di informatica
furnishing for IT spaces

086 carrellone, laboratorio STEM su ruote
carrellone, STEM laboratory trolley on wheels



SPAZI COMUNI COMMON SPACES

mensa 088
cafeteria

studi dei docenti 092
teachers' spaces

biblioteca 094
library

098 scrivanie, postazioni di lavoro
desks, workstations

100 librerie, contenitori, casellari
bookcases, cabinets, file storage system

102 sistema di scaffali MODULAR
MODULAR shelving system

104 arredi per biblioteca
library furnishings

106 sedie operative, impilabili, multiscopo
operational, stackable, multipurpose chairs

108 pannelli fonoassorbenti
acoustic panels



GAM GAM

scuole GAM 112
GAM schools

altri progetti GAM 128
other GAM projects

design GAM 132
GAM design

certificazioni 134
certifications

SPAZI
COMUNI

COMMON SPACES

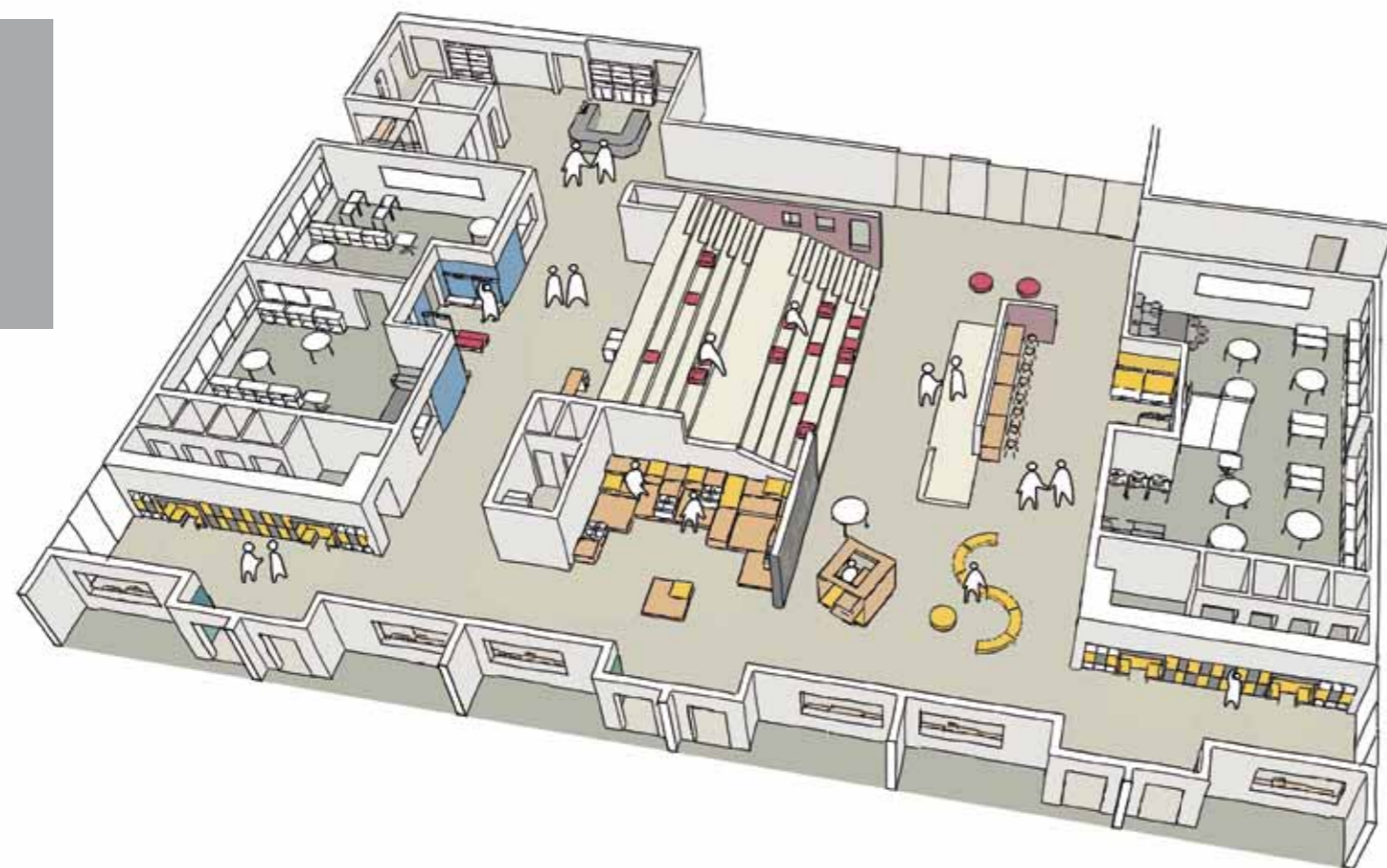

SENTIRSI BENVENUTI nella comunità scolastica

FEELING WELCOME
in the school environment

L'ingresso a scuola è uno spazio che accoglie e comunica. Pannelli per esporre, sedute informali, un banco per informare danno il benvenuto a studenti, docenti, famiglie, ospiti.

The school entrance is a place that welcomes and communicates. Panels for displays and information, informal seating and a reception desk that welcomes students, teachers, families and school guests.



INCONTRARSI

nel cuore della scuola

MEETING

in the school's centre

**Il centro è una piazza, come in città.
È un luogo ricco e articolato, che offre molteplici
opportunità. È lo spazio degli incontri quotidiani
e degli eventi speciali, aperto anche al territorio.**

The centre is a common use space, just like a city square.
It is a rich and complex space that offers a range of
opportunities. It is the space for daily meetings and for
special events, also open to the local community.





TROVARE SPAZIO

in ogni parte della scuola

SHARING SPACES

everywhere in the school

Passaggi, slarghi, anse compongono una rete di luoghi e di occasioni. Arredi originali offrono a tutti modo di riunirsi e confrontarsi oppure di appartarsi per studiare, scrivere, ascoltare musica, in gruppo o da soli.

Corridors, corners and open spaces provide a network of places and of opportunities.

Original furnishing offers everyone the chance to gather and discuss or to slip away to study, write, listen to music, in groups or alone.



PRENDERE TEMPO

sulla soglia delle aule

TAKING TIME

around the classrooms

Nessuno spazio è trascurato.
Anche disimpegni e spogliatoi sono luoghi piacevoli.
Nicchie, panche, sedute informali trasformano ogni angolo
in un posto dove stare bene, parlare tra amici, leggere,
consultare un tablet.

No space is overlooked.
 Even the access areas and locker rooms are pleasant.
 Niches, benches, informal seating transform every corner
 into a welcoming place to chat with friends, read, use a tablet.



**SISTEMA
PER SPAZI D'INGRESSO**
per accogliere, informare, comunicare

FURNISHING
FOR ENTRANCE /
RECEPTION AREAS
for receiving, informing, communicating

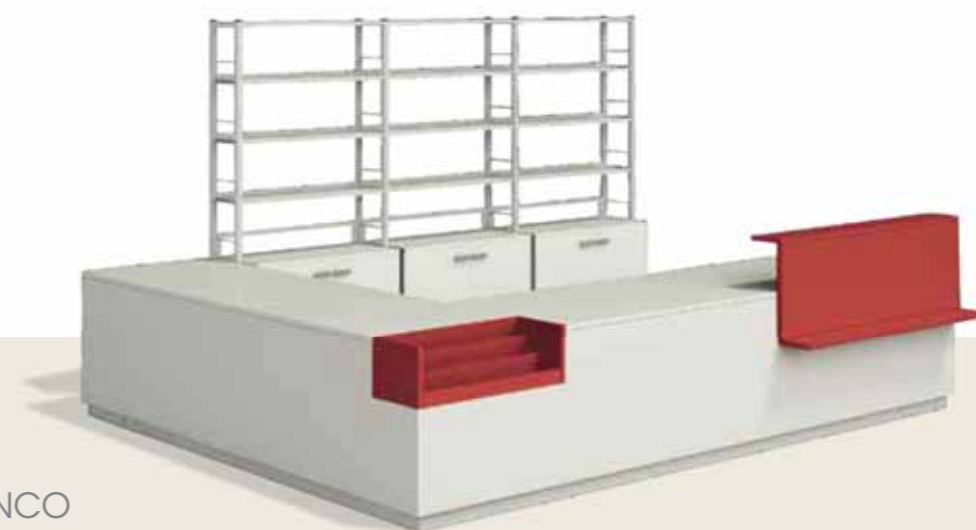

CONTENITORI RETROBANCO
STORAGE UNITS BEHIND THE SERVICE COUNTER

Contenitori chiusi ad ante e scaffali completano le composizioni dei banchi per l'accoglienza.

Storage units and shelving enhance the service counter function.

Banchi lineari, ad angolo e curvilinei, scaffali e contenitori. Un sistema adatto ad allestire grandi atri e ogni ambito di ingresso.

Straight, angled or curved desks, shelves and storage units. A system designed to furnish large receptions and any kind of access area.



INTERMEDIO
intermediate module
H 75 cm



INTERMEDIO CON INCASSO
recessed intermediate module
H 75 cm



INTERMEDIO CURVO
curved intermediate module
H 75 cm



TERMINALE
end module
H 75 cm



TERMINALE CON INCASSO
recessed end module
H 75 cm



TERMINALE CURVO
curved end module
H 75 cm



ANGOLO
square corner module
H 75 cm



ANGOLO CON INCASSO
recessed corner module
H 75 cm



ANGOLO TRIANGOLO
angled corner module
H 75 cm



ANGOLO CURVO
curved corner module
H 75 cm



PIANO CONSULTAZIONE BASSO
low counter
H 75 cm



60x80 cm 80x80 cm
60x120 cm 80x120 cm
60x140 cm 80x140 cm
60x160 cm 80x160 cm

PIANO CONSULTAZIONE ALTO
high counter
H 100 cm



60x80 cm 80x80 cm
60x120 cm 80x120 cm
60x140 cm 80x140 cm
60x160 cm 80x160 cm

ESPOSITORE
display module
H 25 cm



60 cm
80 cm
120 cm
140 cm
160 cm

RIALZO PORTABORSE
upper counter module with bag shelf
H 50 cm



80 cm
120 cm
140 cm
160 cm

VANO SCHERMO
high counter module
H 25 cm



80 cm
120 cm
140 cm
160 cm

VANO SCHERMO CURVO
curved high counter module
H 25 cm



R 55X25 cm
R 155X25 cm

MATERIALI E COLORI
MATERIALS AND COLOURS

Banchi, accessori e parti metalliche sono disponibili in un'ampia gamma di colori coordinati con gli altri elementi dell'arredo.

Counters, accessories and the metal shelving are available in a wide range of colours co-ordinated with the other elements.

struttura metallica
metal shelving



acero
maple

**PEDANE,
PANCHE componibili**
per incontrarsi, conoscersi, rilassarsi

STAGES,
MODULAR BENCHES
for meeting and relaxing



Sedute che fanno luoghi di incontro e segnano passaggi e percorsi.

Seats that create places for meeting, sharing and relaxing.

PEDANE
STAGES

Elementi modulari quadrati e rettangolari, in più dimensioni, in tre altezze, realizzano composizioni a gradoni.
Moduli su due ruote si spostano facilmente.

Square or rectangular shaped modular elements, in various sizes and three different heights, for creating raised spaces in a variety of forms.
Modules on two castors that can be moved around easily.

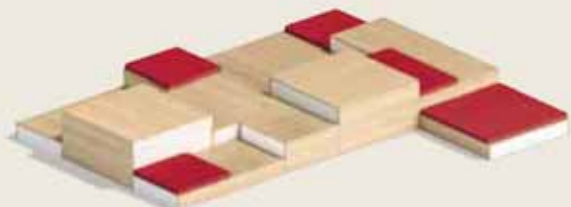

PEDANA QUADRATA
square stage
80x80 cm



H 19 cm
H 38 cm
H 57 cm

PEDANA SU RUOTE
square stage on castors
H 19 80x80 cm



PEDANA QUADRATA GRANDE
large square stage
160x160 cm



H 19 cm

PEDANA RETTANGOLARE
rectangular stage
80x160 cm



H 19 cm
H 38 cm

CONTENITORE
storage box
80x80 cm



H 19 cm
H 38 cm

CUSCINI PEDANA
cushions for stage
H 3 cm



40x40 cm
40x80 cm
80x80 cm

PANCHE
BENCHES

Elementi modulari in più lunghezze, in due versioni per varie composizioni.
Nel fronte o nei fianchi possono contenere panchetti o cassetti su ruote.
Elementi d'angolo permettono di realizzare percorsi e ambiti raccolti.

Modular elements of various lengths, in two versions for different layouts.
At the front or on the sides they can contain small benches or storage units on castors.
Corner elements allow the formation of linear passageways and bends.



PANCA
bench
H 38 cm



45x80 cm
45x120 cm
45x180 cm

PANCA CON VANO
bench with open compartment
H 38 cm



45x120 cm
45x180 cm

PANCA CON FRONTE APERTO
bench with open front
H 38 cm



45x80 cm
45x120 cm
45x180 cm

ANGOLO
corner element
H 38 45X45 cm



CUSCINO
cushion
H 3 34x34 cm



MATERIALI E COLORI
MATERIALS AND COLOURS

Ogni elemento di panche e gradoni è realizzato con due finiture: una per piano di seduta e due fianchi, l'altra per gli altri due fianchi.
La gamma dei colori è la stessa utilizzata per il sistema dei contenitori.

Each element of benches and risers is made in two finishes: one for the seating surface and two sides, the other for the other two sides.
The colour range is the same used for the cabinet system.



morbidi
soft furnishing



PANCHETTO
small bench
H 33 40x40 cm



CASSETTO SU RUOTE
drawer unit on castors
H 33 40x40 cm



GRADONI, PANCHE TELESCOPICHE

per riunirsi, ascoltare, dibattere

TWO-TIERED SEATING,
TELESCOPIC BENCHES

for getting together, listening,
debating



Sedute che fanno arene, tribune, cavee, piccole piazze.

Seats that create group spaces for collaborative activities, teaching and group study.

GRADONI

TWO-TIERED SEATING

Sedute a due livelli, su due ruote, compongono arene mobili.
I vani a giorno nello schienale contengono i cuscini o altri oggetti.
Il modulo angolare unisce le tribune in piccoli teatri.

Two-level seating, on two castors, for mobile arenas.
The open compartments inside the backrest can store cushions or other objects.
The corner module joins the stands to make small auditoriums.

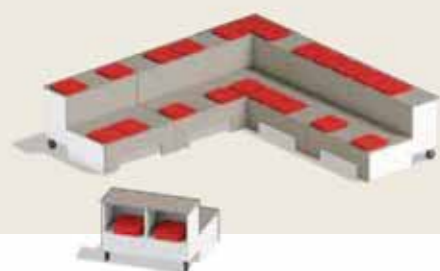

GRADONE
two-tiered seating
H 76 105x105 cm



GRADONE ANGOLO
corner two-tiered seating
H 76 105x105 cm



CUSCINO
cushion
H 3 34x34 cm



morbidi
soft furnishing



3 PANCHE TELESCOPICHE
3 telescopic benches
L 120-180 cm

DIMENSIONI

SIZES

Altezze, profondità e lunghezze delle tre panche consentono di riporle una dentro l'altra e occupare poco spazio.

The heights, depths and lengths of the three benches make it possible to nest them one inside the other in a small space.

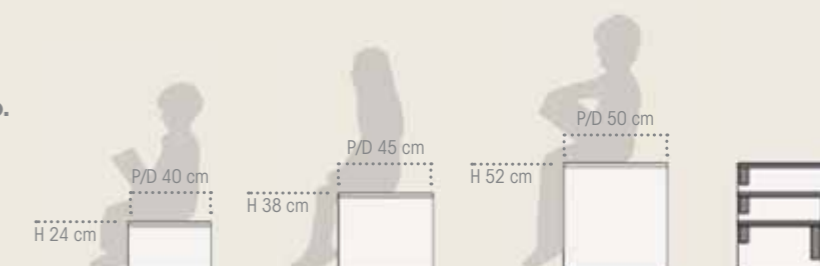

COMPOSIZIONI

LAYOUTS

Panche di tre altezze diverse, da 24 a 52 cm, formano le tribune di piccole cavee o auditorium.

Benches of three different heights, 24, 38 and 52 cm, form ideal spaces for group activities.

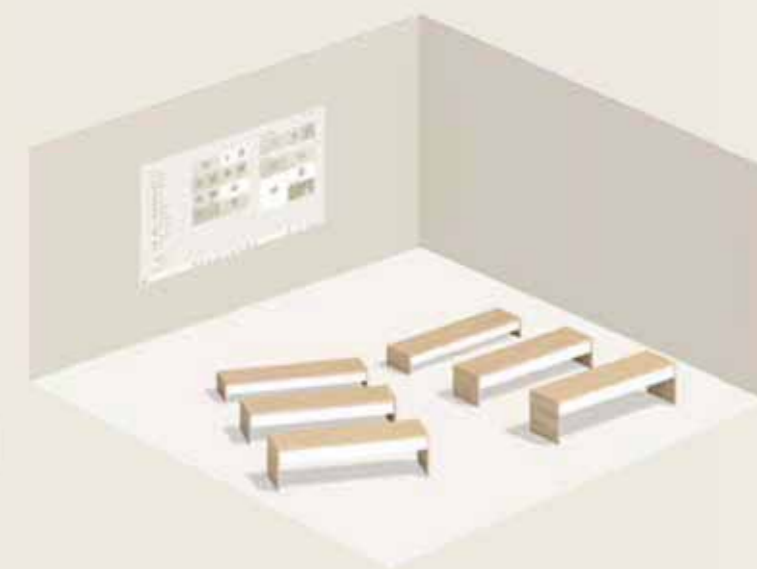

**PANNELLI, SCHERMI,
ANGOLI STUDIO**
per esporre, studiare, lavorare

PANELS, SCREENS,
STUDY CORNERS
for displaying, studying, working



Pannelli per esporre e schermare, tavoli aggregabili con contenitori.
Oggetti che trasformano angoli della scuola in spazi di lavoro informali, aperti, utili.

Panels for exhibiting and screening, modular tables with open cabinets.
Objects that transform corners of the school into informal, open workspace.

PANNELLI

PANELS

pannello H 155x60, base H 12 60x60 cm, H totale 167 cm
Panel H155X60, base H 12X60X60 cm, total H 167 cm

Pannelli con intelaiatura metallica su piedi o su ruote.
Sono disponibili lisci, con fori o fresature, in sughero, scrivibili neri o bianchi, magnetici, fonoassorbenti in molti colori.

Panels with metal frame on feet or castors.
Available plain, with holes or slots, made of cork, whiteboard in black or white finish, magnetic, acoustic sound absorbing in a wide choice of colours.



TAVOLO STUDIO 1
study table 1
H 75-100 60x165cm

Tavolo con contenitore e struttura metallica, in due altezze.

Table with open storage and metal frame, two different heights available.



TAVOLO STUDIO 2
study table 2
H 75-100 60x165 cm

Tavolo con fianchi in legno, in due altezze.

Table with wooden panel sides, two different heights available.



TAVOLO STUDIO 3
study table 3
H 75-100 60x165 cm

Tavolo con contenitore e fianco in legno, in due altezze.

Table with open storage and wooden panel side, two different heights available.

COMPOSIZIONI

COMPOSITIONS

I tavoli studio si aggregano per formare ambienti di lavoro di differenti dimensioni e geometrie.

The study tables can be placed together to create workspaces of a variety of sizes and shapes.

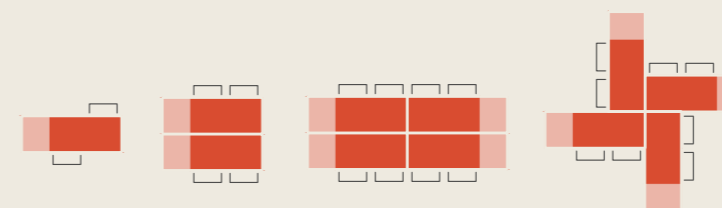

CONTENITORE SOPRAPIANO

COUNTERTOP CONTAINER
H 37 45x60 cm

Il contenitore soprapiano completa la postazione di lavoro.

The countertop open cabinet completes the workstation.



SEDUTE MORBIDE

per rilassarsi, aspettare,
parlare con un amico

SOFT SEATING

for relaxing, waiting,
chatting with friends



Poltrone, pouf, sedute componibili di varie dimensioni e geometrie. Pezzi speciali e un sistema lineare e versatile per fare di ogni spazio un ambiente ospitale.

Armchairs, benches and modular seats of different sizes and shapes. A versatile system for making a room welcoming at any time.



TONA
TONA
H 42-110 77x77 cm

Poltrona con base metallica cromata o verniciata in nero e rivestimento in ecopelle o tessuto ignifugo.

Armchair with chrome-plated or black painted metal base, upholstered in synthetic leather or fire-resistant fabric.



NETTO
NETTO
H 42-130 70x150 cm

Divano con schermo acustico, con base metallica cromata o verniciata in nero e rivestimento in ecopelle o tessuto ignifugo.

Sofa with acoustic panels, with chrome-plated or black painted metal base, upholstered in synthetic leather or fire-resistant fabric.

POUF QUADRATO
square bench
H 38 cm



45x45 cm
80x80 cm

POUF RETTANGOLARE
rectangular bench
H 38 cm



45x80 cm
45x120 cm

POUF CURVO
curved bench
H 38 45xR100cm



POUF TONDO
round bench
H 38 D 80 cm



POUF LUNA
half-moon bench
H 38 D 80 cm



morbidi
soft furnishing



SISTEMA POUF

BENCH SYSTEM

Semplici sedute quadrate, rettangolari e curvilinee si uniscono in una grande varietà di composizioni. Con il POUF LUNA si disegnano fiori, nuvole e linee di ogni curvatura.

Simple square, rectangular and curved benches come together to create a wide range of layouts. With the half-moon bench, flowers, clouds and lines with all kinds of curves are possible.

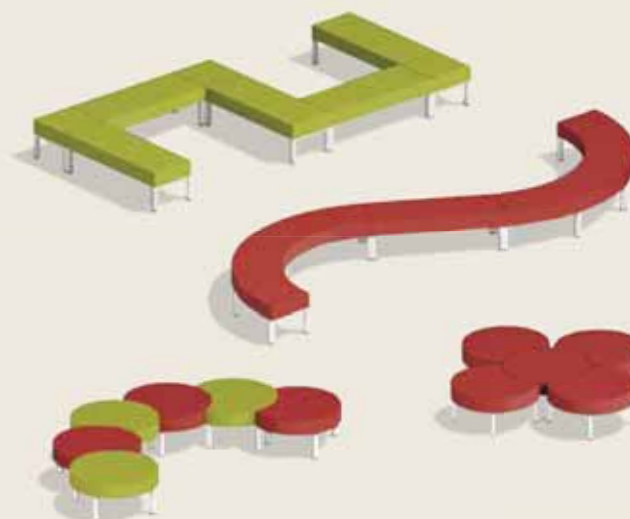

POUF E CONTENITORI

BENCHES AND CABINETS

La base metallica del SISTEMA POUF è alta 24 cm, mentre quella delle sedute coordinate con i contenitori è alta 12 cm (vedi pagina 053). Entrambe complessivamente sono alte 38 cm.

The metal base of the BENCH SYSTEM is 24 cm high, while that of the seats co-ordinated with the cabinets is 12 cm high (see page 053). Both seats are 38 cm high overall.

H 38 cm
H 24 cm

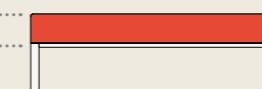

H 38 cm
H 12 cm

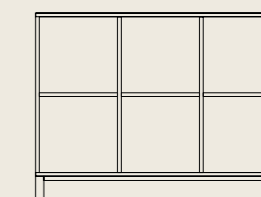

AULE, SPAZI DI GRUPPO

CLASSROOMS,
GROUP SPACES

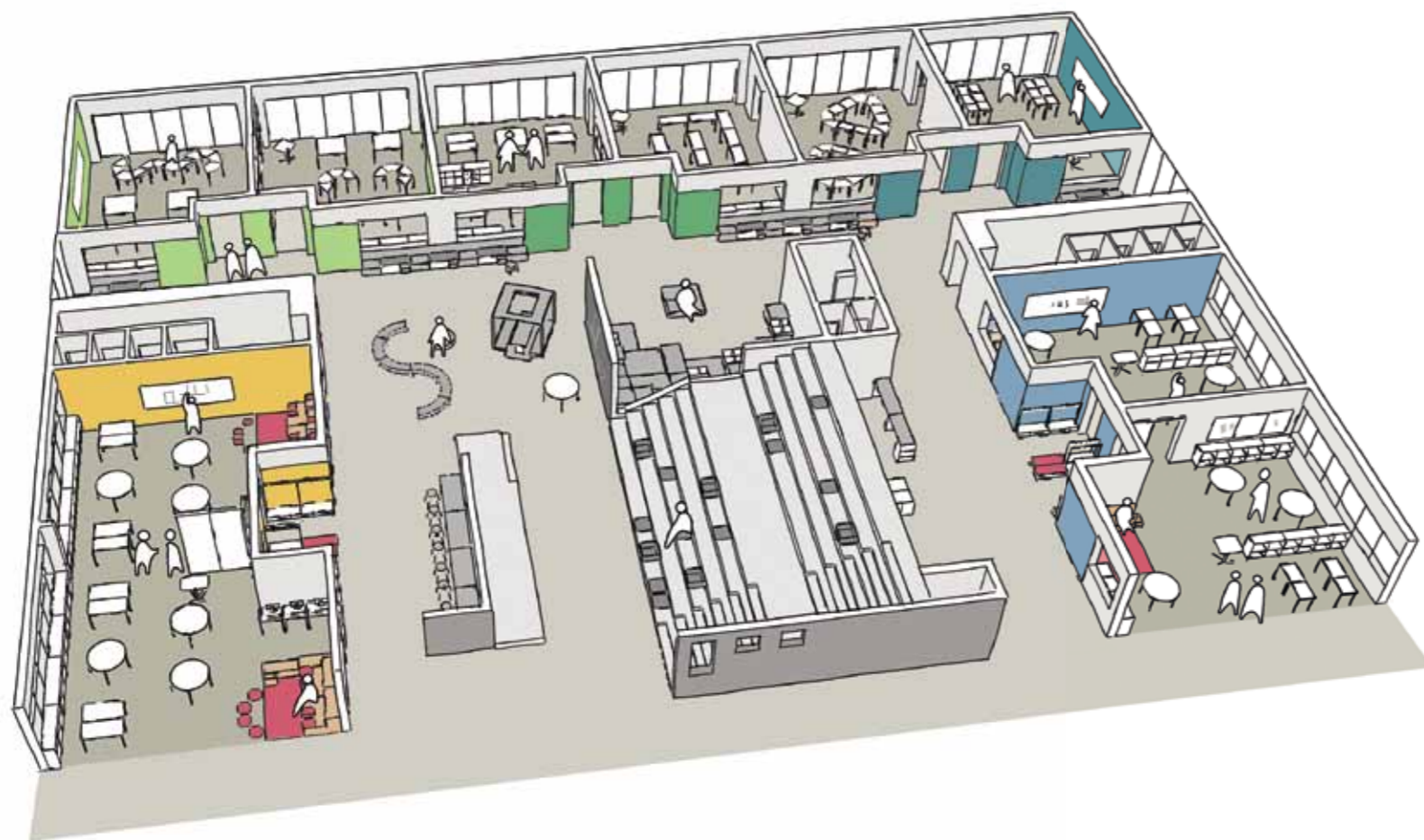

PREDISPORRE spazi policentrici

SETTING UP polycentric spaces

L'ambiente didattico è una composizione di ambiti diversi, integrati e complementari.

L'insegnamento frontale è superato da altri modi di condividere, discutere, elaborare.

La cattedra non è il punto di fuga di una prospettiva unica, è una postazione mobile di lavoro.

The educational environment is made up of different spaces that are integrated and complementary.

Frontal teaching is replaced by new ways of sharing, discussing and learning.

The teacher's desk is not the vanishing point of a single perspective but rather a mobile workstation.



spazio per gruppi
group learning

spazio individuale
individual space

presentazioni
presentations

assemblea
meetings



APPRENDERE

in tanti modi

LEARNING

in a variety of ways

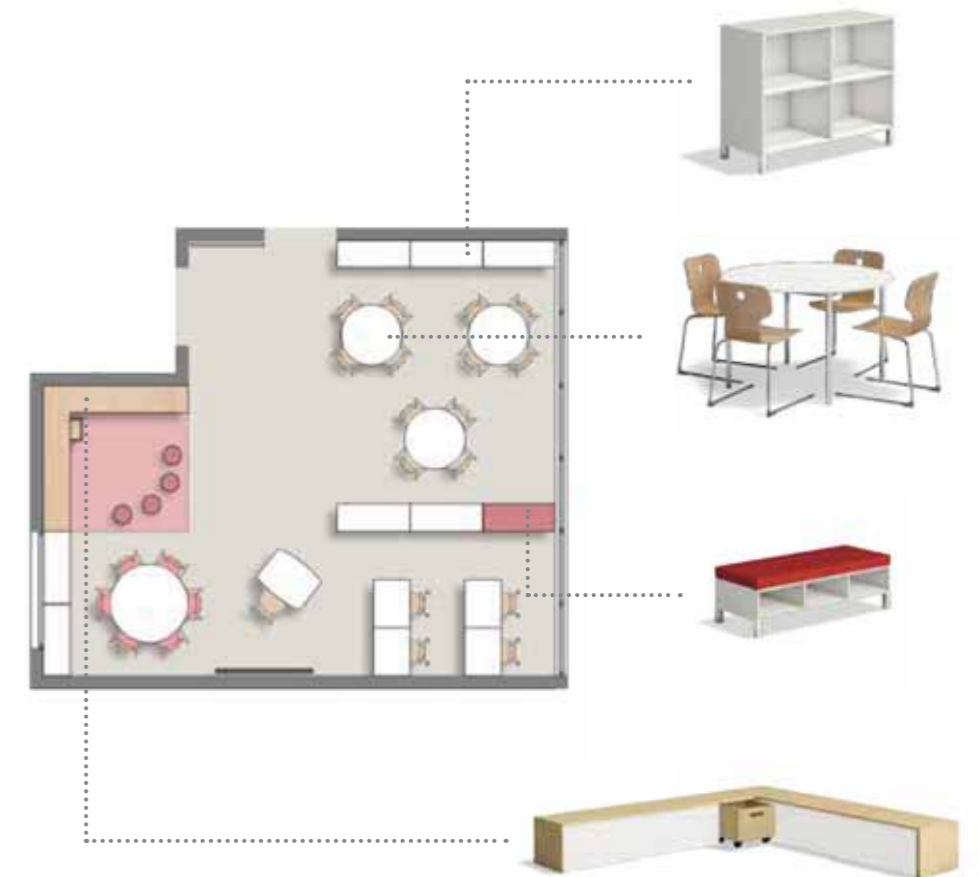

L'aula offre opportunità molteplici e diversificate a gruppi di studenti. Ci si riunisce, si discute, si ascoltano presentazioni, si lavora su tavoli in gruppo, si svolgono prove individuali. Arredi modulari componibili articolano lo spazio e definiscono ambiti flessibili.

The classroom offers groups of students many and diversified opportunities. They get together, they discuss, they listen to presentations, they work in groups at tables, they work on their own. Modular furnishings are used within the space to provide flexible learning environments.



CAMBIARE

ogni giorno

CHANGING

every day

L'aula non è uno spazio fisso. Si allestiscono ambienti adatti a momenti assembleari, di dibattito, per lavoro in gruppo e anche per didattica frontale. Con gli stessi elementi, l'arredo si modifica per offrire possibilità diversificate.

The classroom is not a fixed space. Environments suitable for collaborative work, discussion, and also for frontal teaching can be arranged as required. With the same elements, the furnishing changes to offer a wide range of possibilities.

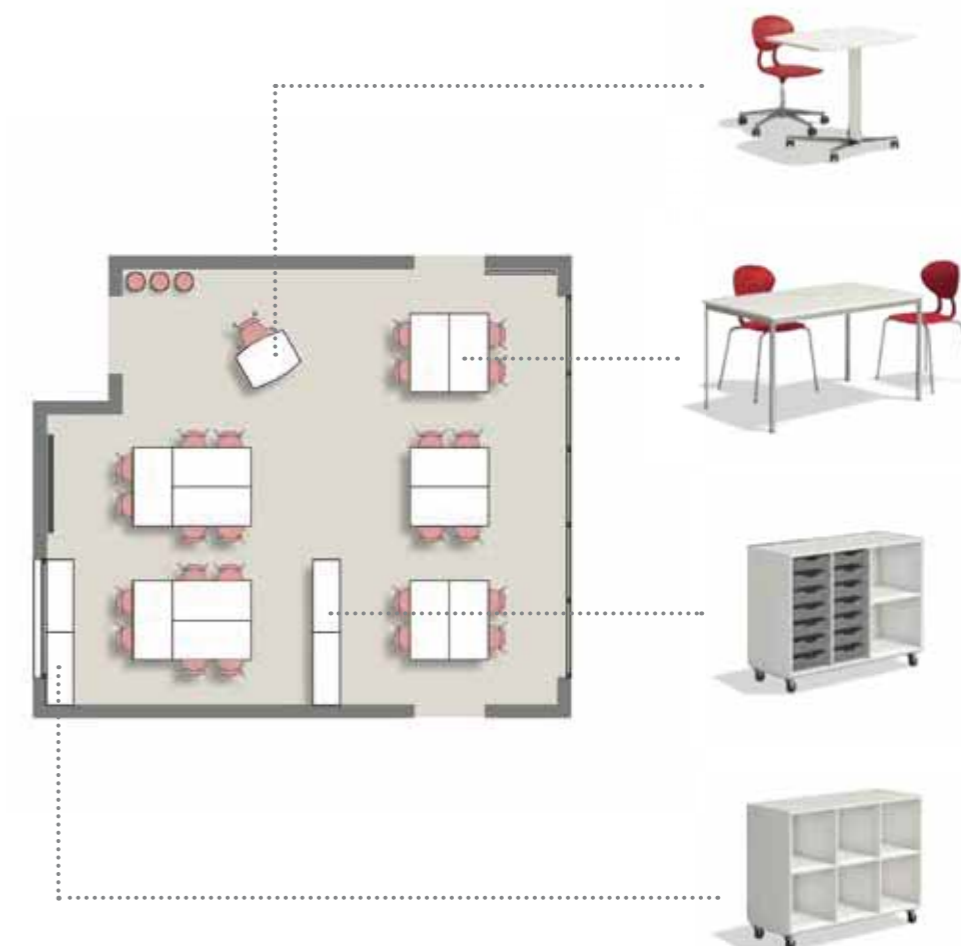



TRASFORMARE lo spazio didattico

TRANSFORMING the educational space



**L'aula può cambiare radicalmente.
Si compongono ampie aree di lavoro o ambiti
frazionati e spazio libero.
I banchi si uniscono in grandi tavoli oppure si mettono
da parte piegati o impilati.**

The classroom can change radically.
Large work areas or different work segments and free space
can be provided.
The desks come together to become large tables or can be set
aside folded or stacked.

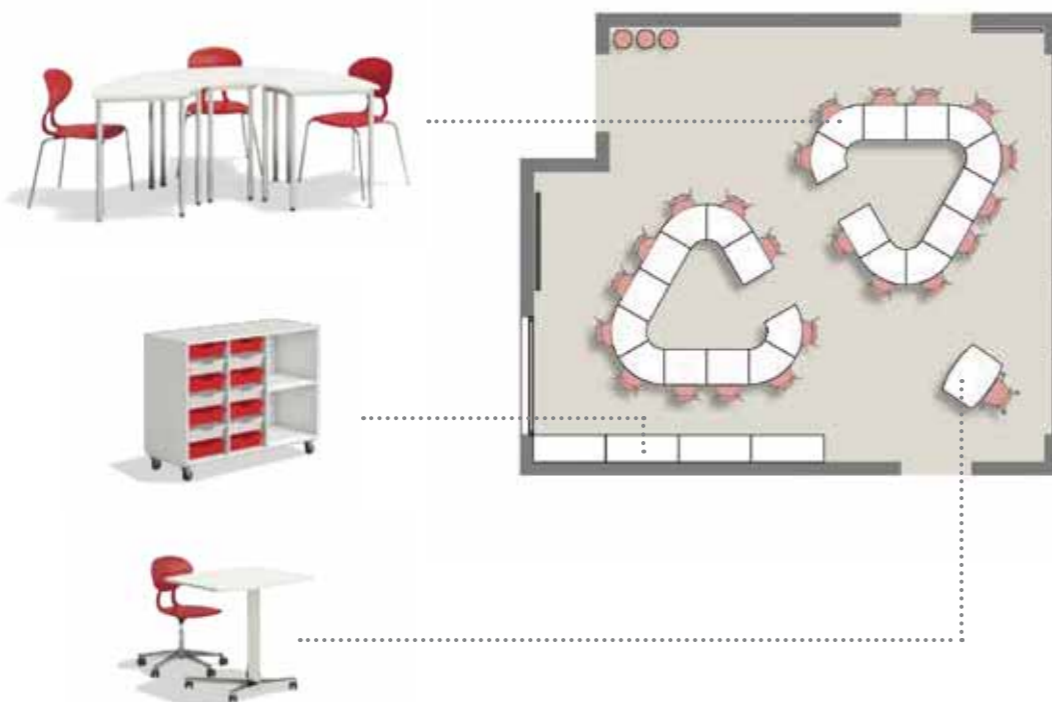

COLLABORARE

in configurazioni a geometria variabile

COLLABORATING

in layouts of different shapes



**L'aula è luogo di confronto e scambio.
L'apprendimento cooperativo promuove la collaborazione tra studenti.
I banchi si aggregano per formare basi per team di lavoro oppure si dividono
per gruppi meno numerosi o in postazioni individuali.**

The classroom is a place for discussion and sharing.
Collaborative learning promotes interaction among students.
The desks come together to create the bases for work teams or are separated
into smaller groups or into individual desks.



PRESENTARE

ricerche, studi, lezioni

PRESENTATION

lectures, lessons and talks

L'aula è uno spazio che comunica.
Le vecchie lavagne di ardesia sono trasformate in pareti attrezzate e multimediali.
Schermi, pannelli scrivibili, lavagne compongono un mosaico che supporta lo scambio tra studenti e tra studenti e docenti.

The classroom is a space that communicates.
The old slate blackboards have transformed into wall units and multimedia walls.
Screens, panels, writing boards create a mosaic that helps interaction amongst students and between students and teachers.

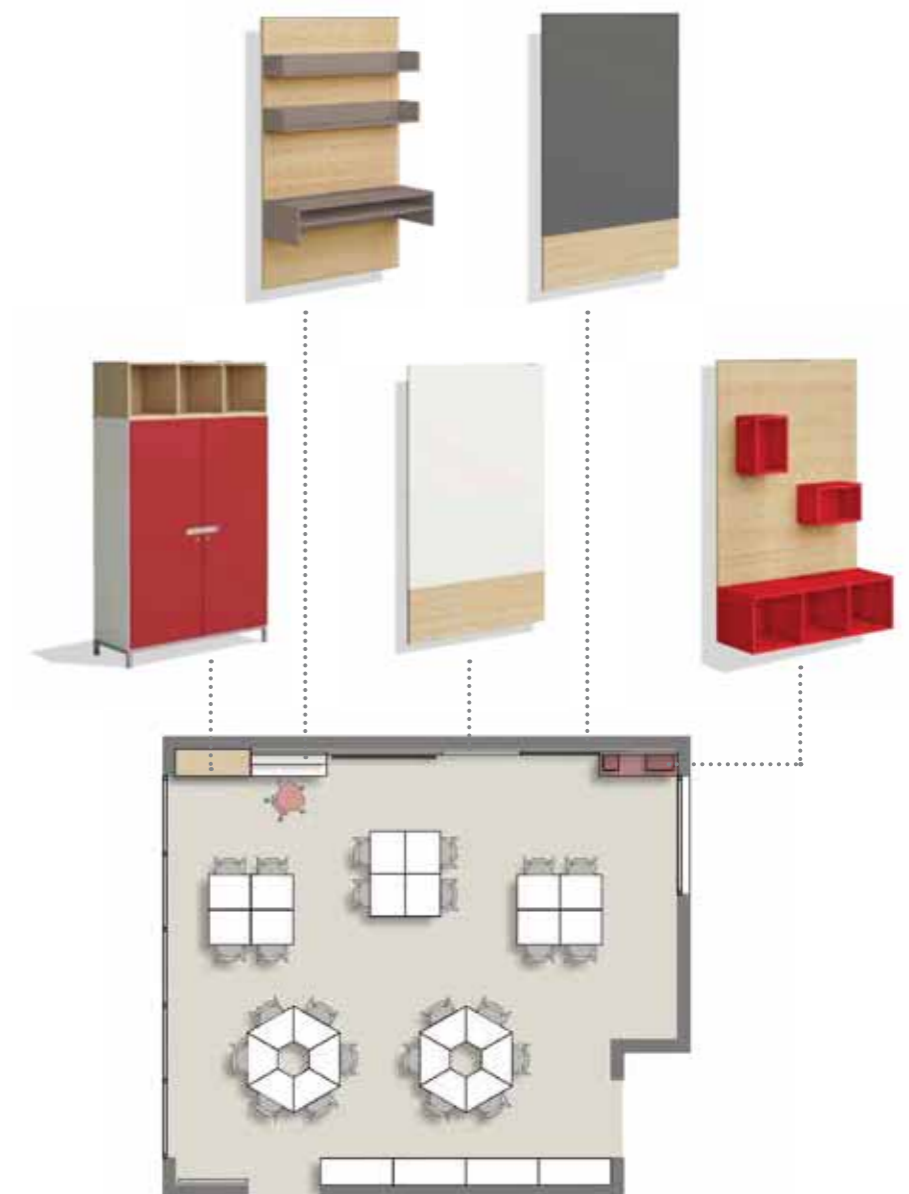

AULE, SPAZI DI GRUPPO

CLASSROOMS, GROUP SPACES

SISTEMA DI CONTENITORI

per riporre, conservare, ordinare

CABINETS

for storing, displaying and arranging



Contenitori chiusi e a giorno, rettilinei e curvilinei. Un assortimento completo per arredi funzionali e flessibili.

Closed and open cabinets, both straight and curved. A wide variety of functional and flexible pieces of furniture.

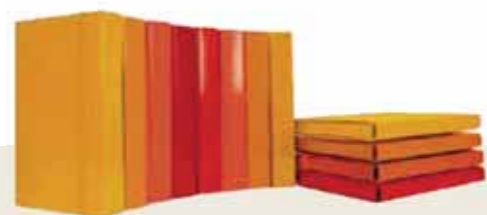

DIMENSIONI SIZES

La misura base è il raccoglitore standard. Altezze e larghezze degli elementi sono coordinati per comporre un sistema modulare.

The dimension used is the size of the standard file binder. The heights and widths of the elements are coordinated to provide a modular system.

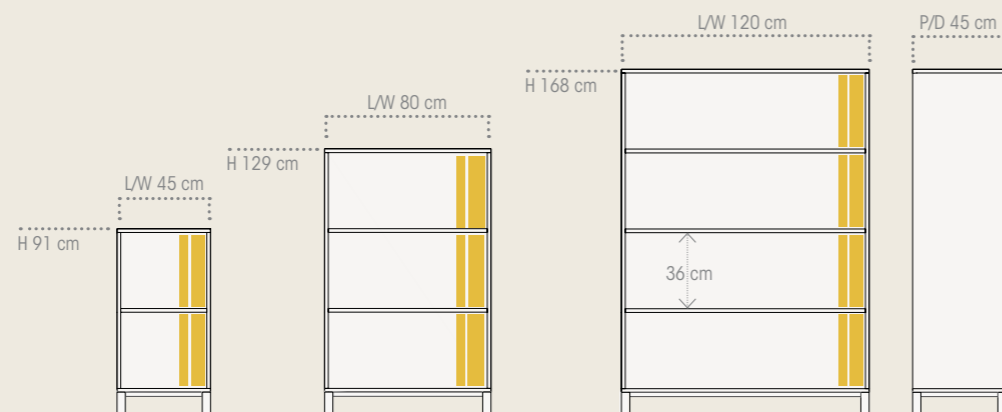

Le ante sono caratterizzate dal disegno essenziale delle maniglie lineari a incasso.

The doors feature ergonomic recessed handles.

Tutte le ante hanno serrature a chiave. Sono disponibili serrature a combinazione e lucchetti.

All doors have key locks. Pad lockable and combination locks are also available.



La base dei contenitori è un telaio metallico su piedi o su ruote. Su richiesta può essere uno zoccolo in tinta.

The base of the cabinets is a metal frame with feet or castors. On request it can be a colour-matching plinth.



MATERIALI E COLORI MATERIALS AND COLOURS

Una gamma di colori per basi metalliche, casse e ante, consente di realizzare una grande varietà di combinazioni cromatiche.

A wide range of colours for the metal bases, compartments and doors allows to create a wide variety of colour combinations.

cassa
carcase

ante
doors

base
base

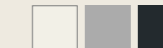

Su richiesta, lo schienale può essere un pannello scrivibile, per trasformare in lavagne il retro dei contenitori.

On request, the back of the cabinets can be a writeable whiteboard.

AULE, SPAZI
DI GRUPPO

CLASSROOMS,
GROUP SPACES

**AMPIA GAMMA DI TIPI
E DIMENSIONI**

per soddisfare le esigenze
di ogni ambiente della scuola

**WIDE RANGE OF TYPES
AND SIZES**

for meeting the needs
of every area of the school



ANGOLO
CORNER

Un modulo a giorno, di larghezza uguale alla profondità, funziona come elemento angolare del sistema. Consente di realizzare composizioni freestanding per suddividere e articolare grandi ambienti.

An open module, as wide as it is deep, works as the corner element of the system. It allows the creation of freestanding compositions for dividing larger rooms into several separate spaces.



L/W 80 cm



H 91 cm



H 129 cm



H 168 cm

L/W 120 cm



AULE, SPAZI DI GRUPPO

CLASSROOMS,
GROUP SPACES

CASSETTI MULTIUSO, LEGGERI, IMPILABILI

per carte, oggetti, materiali

MULTIPURPOSE, LIGHT,
STACKABLE TRAYS

for papers, objects, materials



Gli stessi cassetti possono essere utilizzati sotto il piano dei tavoli o inseriti su guide in appositi vani dei contenitori.

The trays can be used under the tabletop or inserted into the cabinet's compartments.

La base dei contenitori è un telaio metallico su piedi o su ruote.

The base of the cabinets is a metal frame with feet or castors.

	L/W 36 cm	L/W 80 cm	L/W 120 cm
H 79 cm			
H 91 cm			
H 168 cm			

CASSETTI TRAYS

Cassetti in materiale plastico.
Disponibili in tre altezze e sette colori. Il bianco è trasparente.

Trays in plastic material.
Available in three heights and seven colours. White means translucent.



H 7,5 43x31,2 cm

H 15 43x31,2 cm

H 22 43x31,2 cm

SCelta DI ACCESSORI

per completare, arricchire,
diversificare

RANGE OF ACCESSORIES

for completing, enriching, diversifying



Espositori, scaffali, lavagne, mensole, pannelli, sedute, appendiabiti.
Accessori utili per realizzare composizioni varie e piacevoli.

Display panels, shelves, storage, niches, seats and coat hooks.
Accessories useful in creating a varied and attractive solution.

PANNELLI

PANELS
H 77 cm

Pannelli lisci, con fori o fresature, in sughero, scrivibili neri o bianchi, magnetici, fonoassorbenti in molti colori.
Sono disponibili nelle larghezze dei contenitori.

Plain panels, with holes or slots, made of cork, black or white whiteboards, magnetic, acoustic sound-absorbing fabric covered panels in many different colours. Available in the same widths as the cabinets.



RIPIANI COLORATI

COLOURED SHELVES

A richiesta, i ripiani dei contenitori a giorno possono essere colorati come le ante.

On request, the shelves of the open cabinets can be of the same colour as that of the doors.



DIMENSIONI

SIZES

Accessori e pezzi speciali si inseriscono nella griglia dimensionale del sistema.

Accessories and special pieces are used within the dimensional grid of the system.

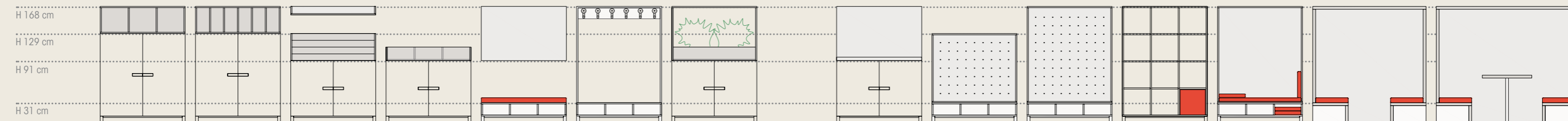

AULE, SPAZI DI GRUPPO

CLASSROOMS, GROUP SPACES

VARIETA' DI PEZZI SPECIALI

per appendere, esporre, sedersi, appartarsi

ACCESSORIES

for hanging, displaying or sitting



ELEMENTO BASE
base unit
H 31 45X80-120 cm

Al sistema dei contenitori si aggiunge un elemento di altezza minima, come base per sedute, appendiabiti, vani multiuso, nicchie.

The cabinet system that includes lower height elements as a base for seats, coat hooks, multipurpose compartments and niches.



MICROSPAZIO
microspace
H 190 190X190 cm

Il pezzo più speciale del sistema è disegnato sulla geometria della NICCHIA. Un piccolo spazio raccolto, una cellula autonoma da inserire in grandi ambienti.

The system's most distinctive element is designed as a niche. A small, meeting space to be placed in larger areas.

CUBO MORBIDO
soft cube stool
H 36 36X36 cm

Da riporre nei vani dei contenitori.
To be stored inside the compartments of the cabinets.

APPENDINI
hangers

Da inserire nei fori dei pannelli.
To be inserted into the holes within the panels.

	L/W 80 cm	L/W 120 cm
TOP A CASELLE cubby top H 38 P/D 45 cm		
TOP ESPOSITORE display top H 38 P/D 45 cm		
TOP ESPOSITORE ORIZZONTALE horizontal display top H 19 P/D 45 cm		
TOP FIORIERA flower box top H 77 P/D 45 cm		
TOP LAVAGNA writing board top H 77 P/D 45 cm		
MENSOLA shelf H 15 P/D 25 cm		
PANNELLO A PARETE wall panel H 77 cm		

	L/W 80 cm	L/W 120 cm	L/W 160 cm	L/W 190 cm
CUSCINO cushion H 7 cm				
APPENDIABITI coat hooks H 168 cm				
VANO MULTIUSO schienale forato multipurpose compartment - back with holes H 98-137 P/D 45 cm				
COCOON cocoon H 137 P/D 45 cm				
NICCHIA niche H 168 P/D 60 cm				

AULE, SPAZI DI GRUPPO

CLASSROOMS,
GROUP SPACES

COMPOSIZIONI ILLIMITATE per articolare spazi

UNLIMITED LAYOUTS
for larger spaces

Contenitori e accessori si aggregano in una grande varietà di configurazioni. Semplici e seriali oppure ricche e articolate, monocrome o policrome, con colori neutri o vivaci.

Cabinets and accessories combine in a variety of configurations. Simple or complex layouts, plain or colourful, with neutral or vibrant colours.



AMBIENTI COMUNI COMMON SPACES

Composizioni a più lati, con angoli, suddividono lo spazio di grandi ambienti e definiscono ambiti.

Different layouts break up the open space of large rooms to provide individual solutions for a variety of uses.

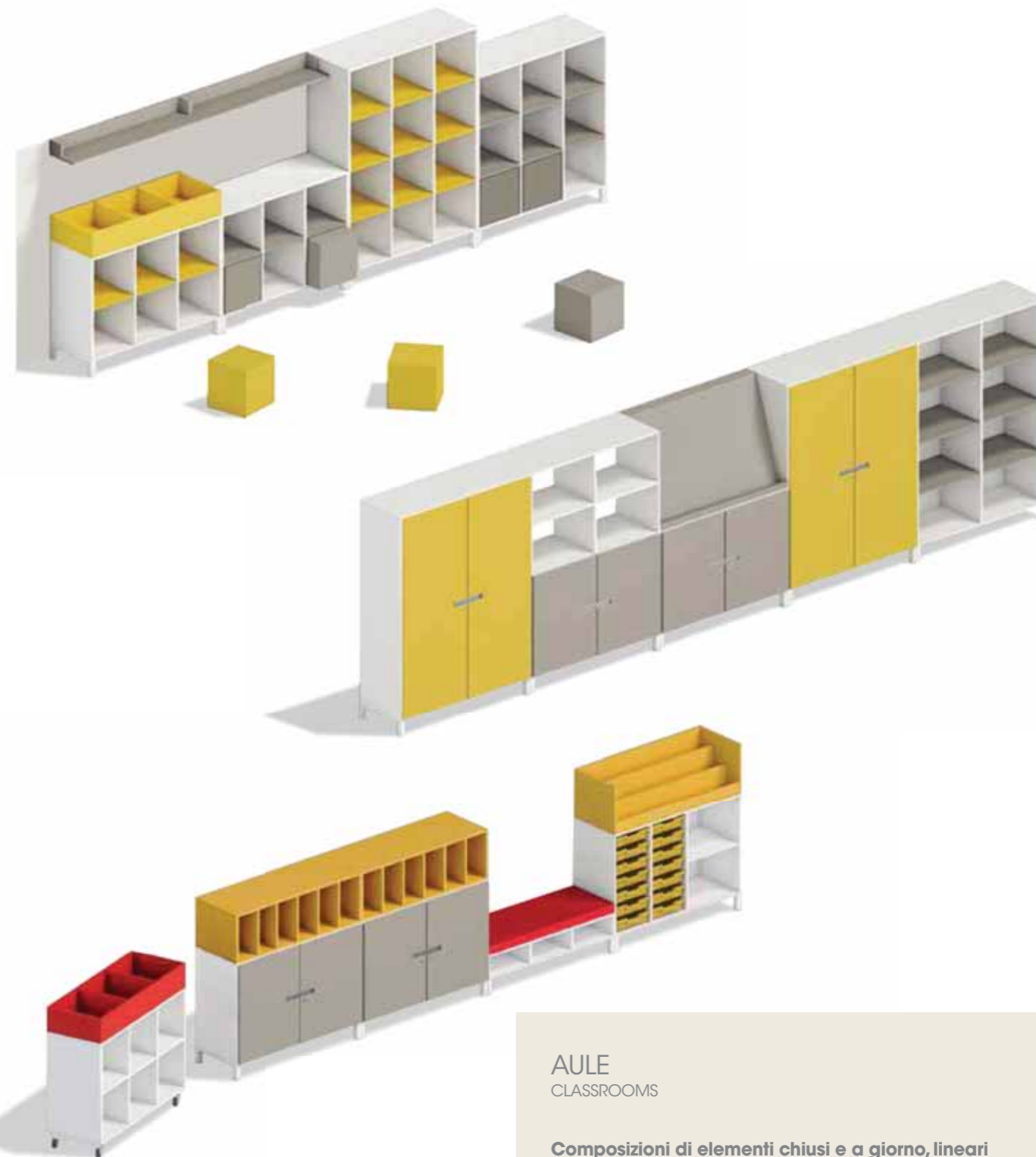

AULE CLASSROOMS

Composizioni di elementi chiusi e a giorno, lineari o articolate, fisse o su ruote, contengono materiali didattici e oggetti personali.

Layouts using closed and open modules on feet or castors can be used to store teaching material and personal belongings.

AULE, SPAZI
DI GRUPPO

CLASSROOMS,
GROUP SPACES

COMPOSIZIONI ILLIMITATE
per attrezzare percorsi

UNLIMITED LAYOUTS
for furnishing corridors
and open spaces

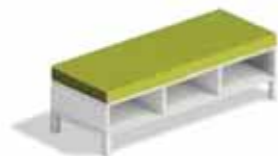
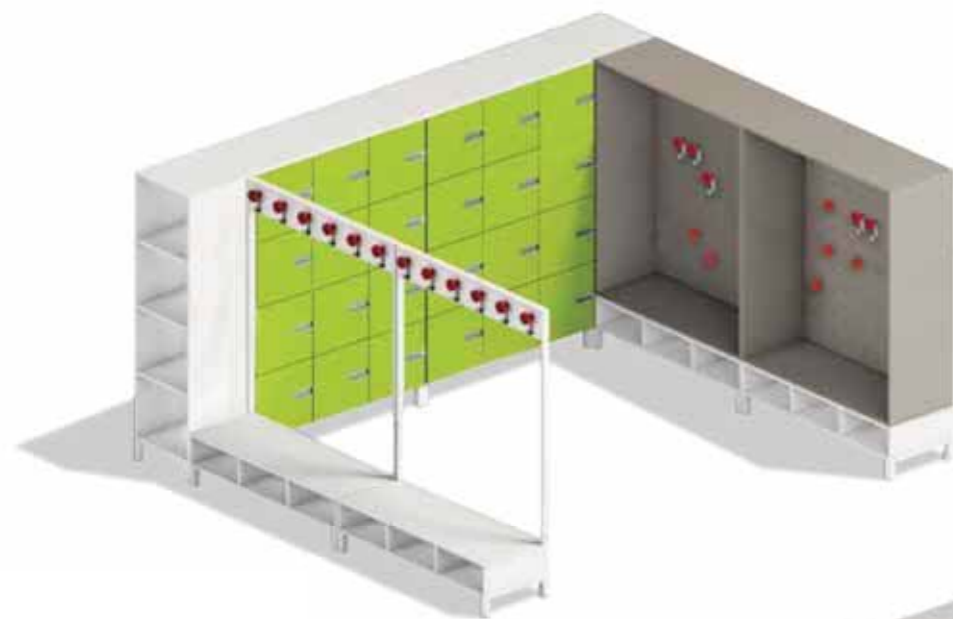

SPOGLIATOI
LOCKER ROOMS

**Composizioni adatte a spazi aperti o corridoi,
da mettere lungo le pareti o come isole al centro
degli ambienti.
Elementi diversi per riporre abiti e oggetti in vari modi.
Trasformano spazi trascurati in ambienti piacevoli,
con angoli per stare insieme.**

Layouts for open spaces or corridors, to be placed along the walls
or as island units.
Different elements for storing clothes and personal effects which
transform empty spaces into pleasant, inviting and useful areas.

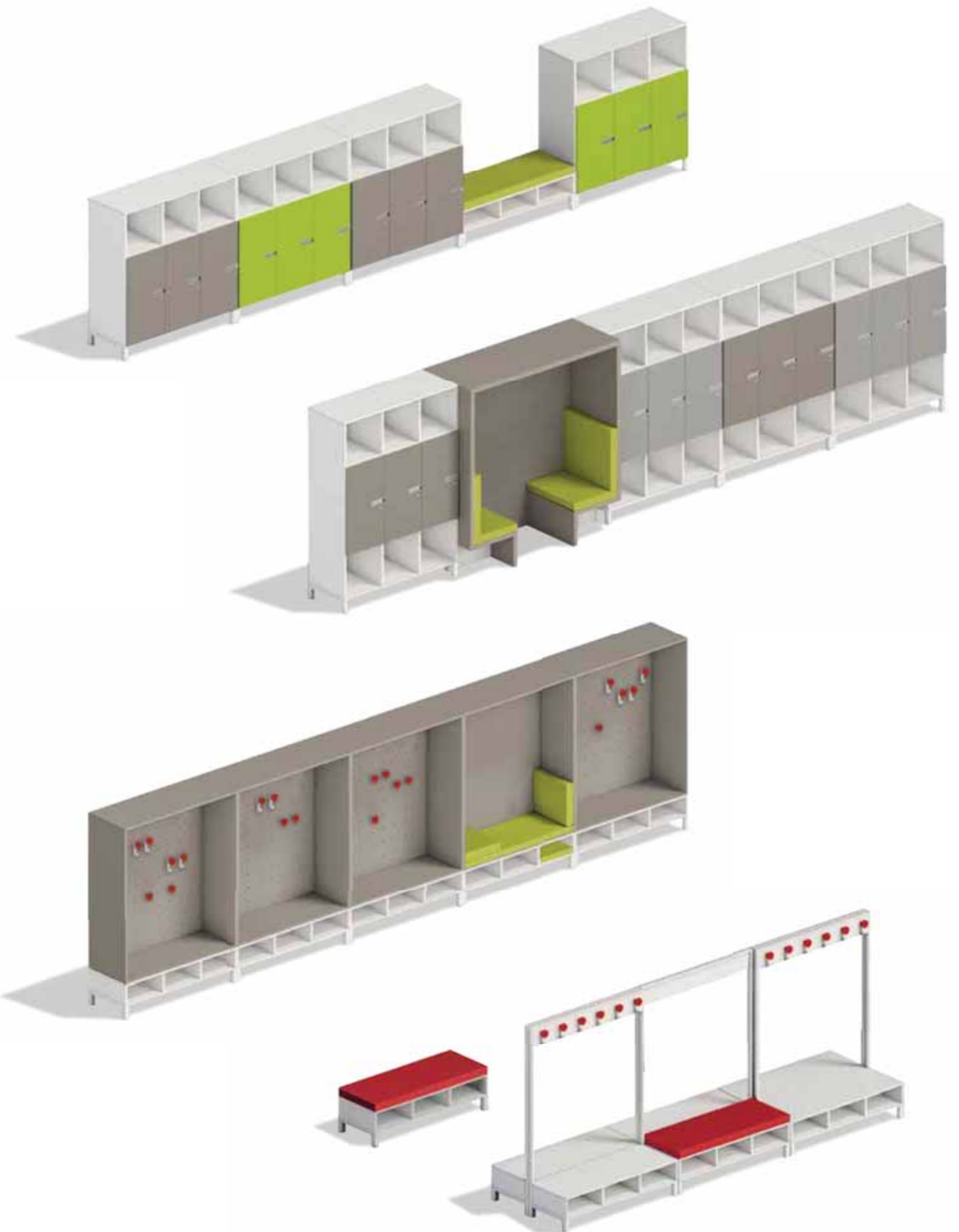

AULE, SPAZI DI GRUPPO

CLASSROOMS, GROUP SPACES

ELEMENTI CURVILINEI per disegnare linee morbide

CURVED UNITS for designing soft shapes



Contenitori e sedute coordinate definiscono ambiti raccolti e accoglienti.

Co-ordinated cabinets and seating define cosy and comfortable arrangements.

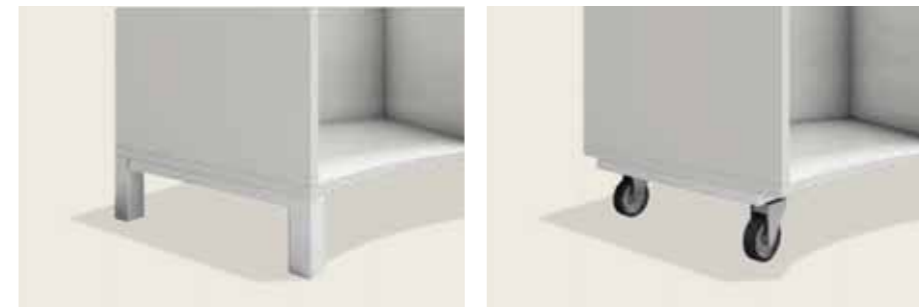
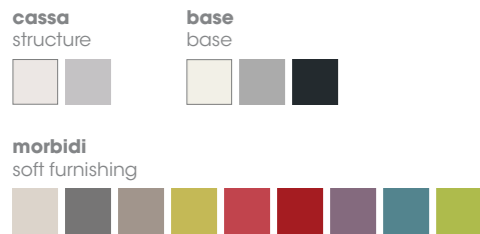

La base dei contenitori è un telaio metallico su piedi o su ruote.

The base of the cabinet is a metal frame on feet or castors.

R 100-145



H 91 cm



H 129 cm



I contenitori curvilinei possono essere concavi o convessi. I moduli hanno vani a giorno passanti oppure con schienale, esterno o interno.

Curved cabinets can be concave or convex. The modules can have compartments or come with an external or internal back.

ALTEZZE HEIGHTS

I contenitori curvilinei sono disponibili in due altezze coordinate con i contenitori lineari.

Curved cabinets are available in two different heights, coordinated with the straight modules.

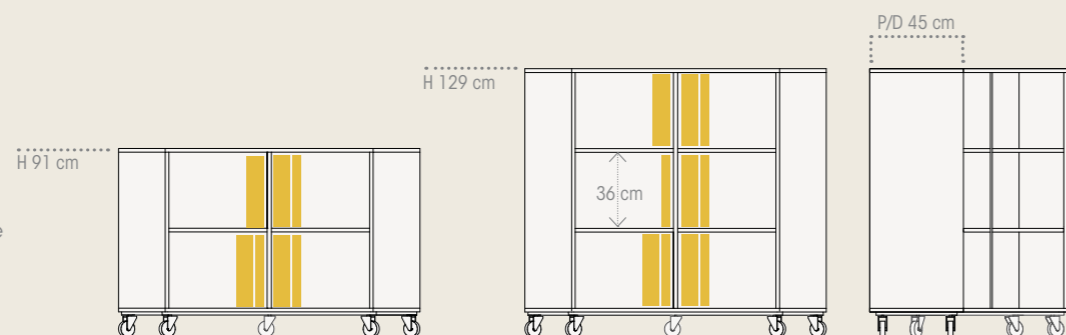

SEDUTE CURVILINEE CURVED SEATS

H 38 cm

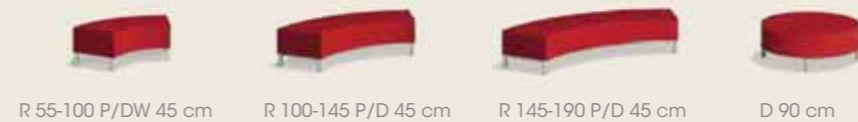

Le sedute coordinate sono disponibili con tre diversi raggi di curvatura: per stare all'interno, all'esterno o in continuità con i contenitori. Il pouf circolare completa il sistema.

The co-ordinated seating program is available in three different radius': for sitting inside, outside or an extension of the cabinets. The round stool completes the range.



COMPOSIZIONI ILLIMITATE
per fare anse, isole, partizioni sinuose

UNLIMITED LAYOUTS
for creating curves,
islands and free flowing partitions

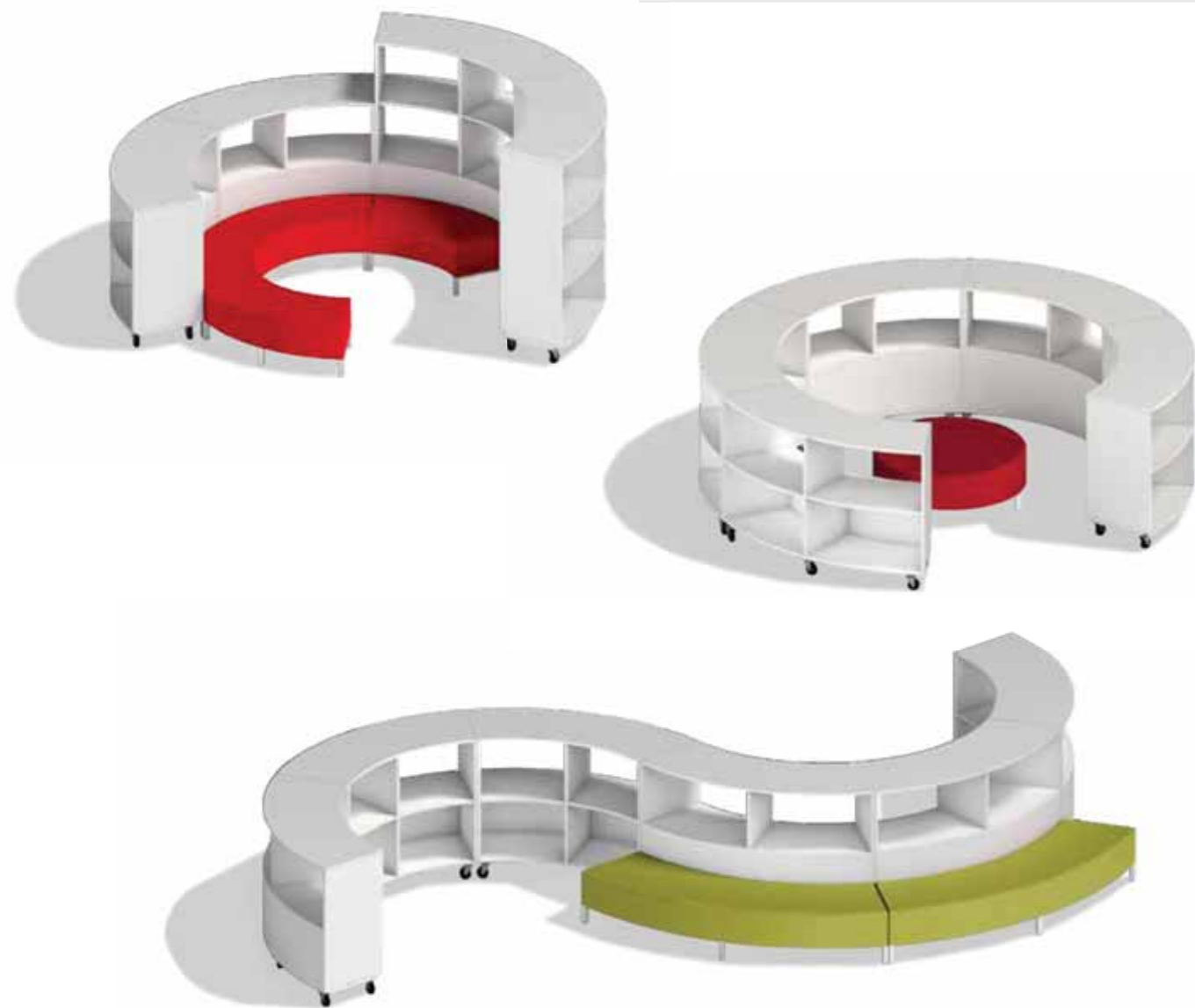

Composizioni di elementi curvilinei costruiscono luoghi protettivi e accoglienti negli spazi della scuola.

Layouts with curved elements create private and also welcoming areas within the school environment.

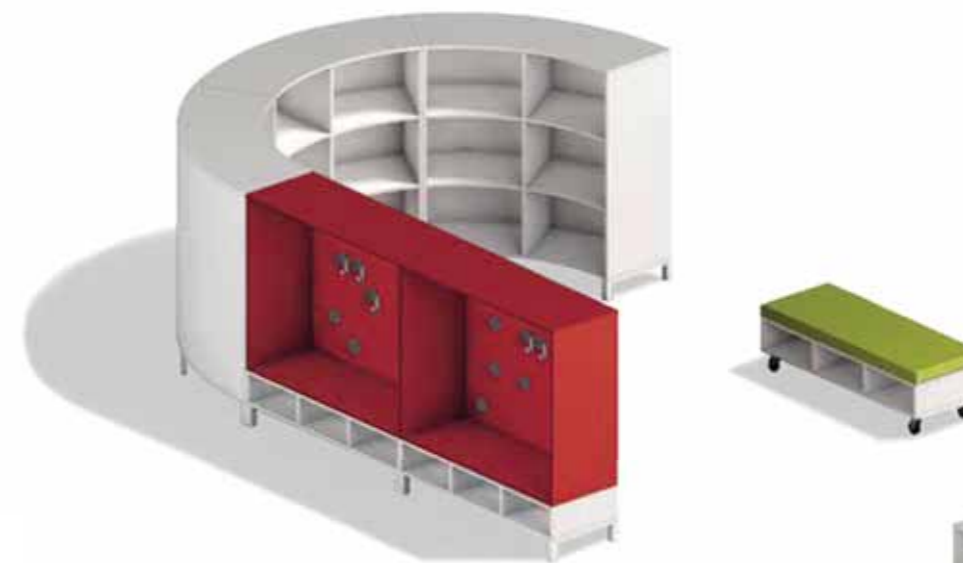
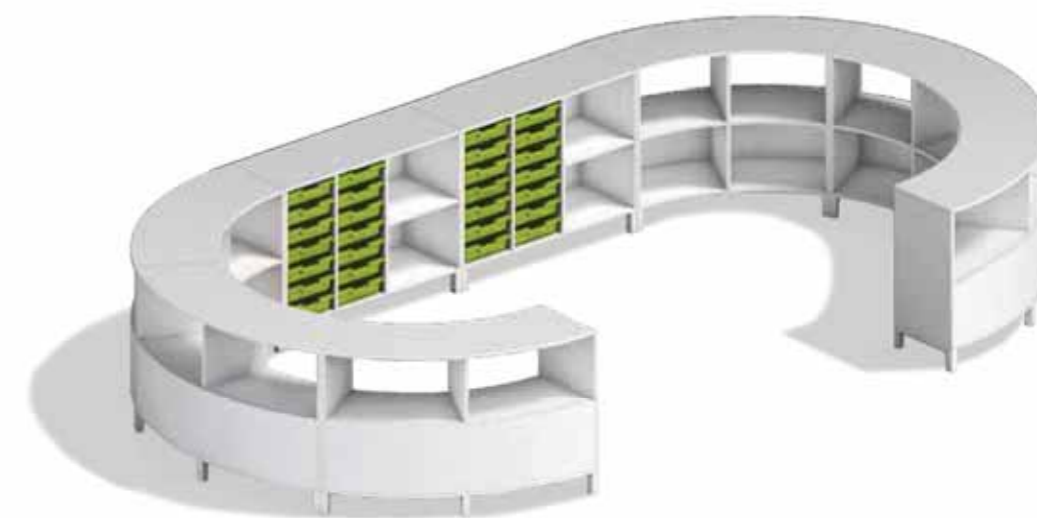

Composizioni di elementi curvilinei e rettilinei ampliano ulteriormente le possibilità. Si possono disegnare ambiti di forme e dimensioni molto varie.

Curved and straight modules offer the possibility of creating a wide range of layouts of different shapes and sizes.

SISTEMA DI TAVOLI
per rispondere ai bisogni di tutti

TABLES
for meeting everyone's needs

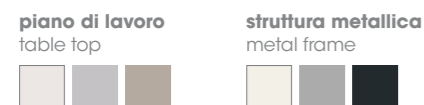

Elementi semplici per combinazioni complesse.
Molto oltre la fissità dei vecchi banchi scolastici, i tavoli degli studenti sono parti di configurazioni variabili e dinamiche.

Simple elements for complex arrangements.
Far from the rigidity of old-school desks, these student tables provide variable and dynamic configurations.

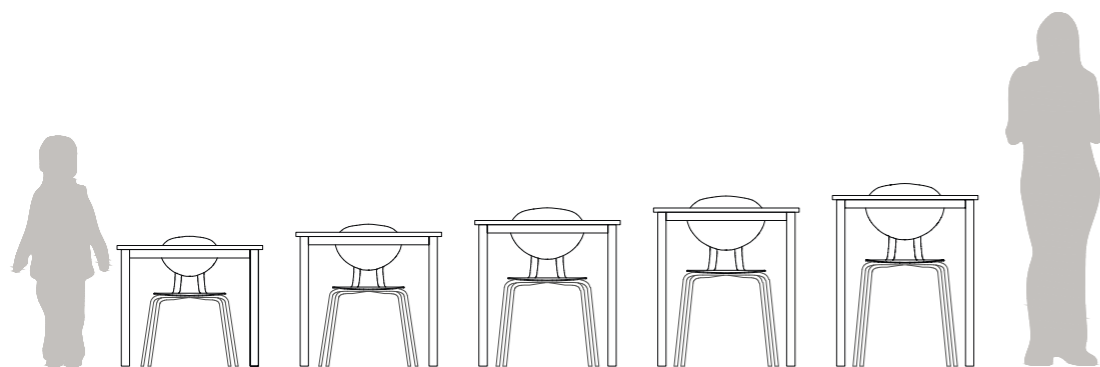

3	table height 59 cm seat height 35 cm	4	table height 64 cm seat height 38 cm	5	table height 71 cm seat height 43 cm	6	table height 76 cm seat height 46 cm	7	table height 82 cm seat height 51 cm
----------	---	----------	---	----------	---	----------	---	----------	---

Tavoli e sedie sono disponibili nelle altezze previste dalla norma UNI EN 1729 per le classi delle scuole dell'obbligo e superiori.

Tables and chairs are available in the heights required by UNI EN 1729 for the students of primary and secondary schools.

ACCESSORI
ACCESSORIES



Su richiesta gli angoli dei piani dei tavoli possono essere stondati.

On request, the corners of the table tops can be rounded.



Ganci, griglie metalliche, cassetti in materiale plastico rendono i tavoli più versatili e funzionali.

Hooks, wire trays, plastic drawers make the tables more versatile and functional.

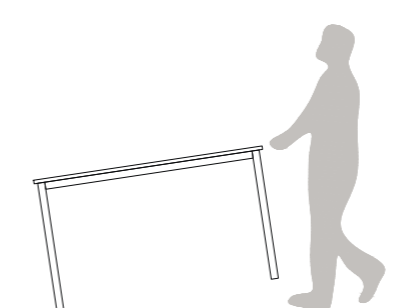

Ruote inserite al piede di due gambe facilitano lo spostamento.

Invisible castors inserted at the ends of two legs allow for easy movement of the tables.



Su richiesta, tutti i tavoli sono disponibili in versione regolabile in altezza con gambe dotate di terminali a vite ad alta portata, con lunghezza di regolazione di 10 o 15 cm.

On request, all tables can be height adjustable, with legs equipped with 10 or 15 cm high screw inserts.

MOLTEPLICITA' DI FORME

per sostenere ogni modalità
di apprendimento

SHAPES AND SIZES

for all teaching environments



TAVOLI IMPILABILI stackable tables



Tavoli quadrati, rettangolari e tondi sono disponibili anche in versione impilabile con due o quattro gambe esterne al piano.

Square, rectangular and round tables are available also in stackable version with two or four legs external to the top's plane.

TAVOLI CON PIANO RIBALTABILE flip-top tables

Tavoli trapezoidali e a settore di cerchio sono disponibili anche con piano ribaltabile per accostamento in poco spazio.

Trapezoidal and curved-sector tables are available with flip-tops, so they take up little space when stored.

	DIMENSIONI SIZES	PIANO RIBALTABILE FLIP-TOP	IMPILABILE STACKABLE	GANCIO PORTAZAINO SCHOOL BAG HOOK	GRIGLIA SOTTOPIANO WIRE TRAYS	CASSETTO IN PLASTICA PLASTIC DRAWER
	65x65 cm 80x80 cm 130x130 cm		■	■	■	■
	50x70 cm 80x120 cm 50x130 cm 80x140 cm 58x70 cm 80x160 cm 65x130 cm 80x180 cm		■	■	■	■
	D 130 cm			■	■	■
	D 100 cm D 130 cm		■	■	■	■
	88x50 cm	■		■	■	■
	30 cm lato					
	130x65 cm	■		■	■	■
	65 cm lato					

	DIMENSIONI SIZES	PIANO RIBALTABILE FLIP-TOP	IMPILABILE STACKABLE	GANCIO PORTAZAINO SCHOOL BAG HOOK	GRIGLIA SOTTOPIANO WIRE TRAYS	CASSETTO IN PLASTICA PLASTIC DRAWER
	88x58 cm R _{int} 30 cm	■		■	■	■
	152x58 cm R _{int} 30 cm			■	■	■
	D 60 cm					
	80x80x113 cm			■		
	85x63 cm		■	■	■	■
	140x140 cm					
	190x190 cm					

GEOMETRIE COORDINATE
per realizzare infinite configurazioni

CO-ORDINATED SHAPES
for creating infinite configurations

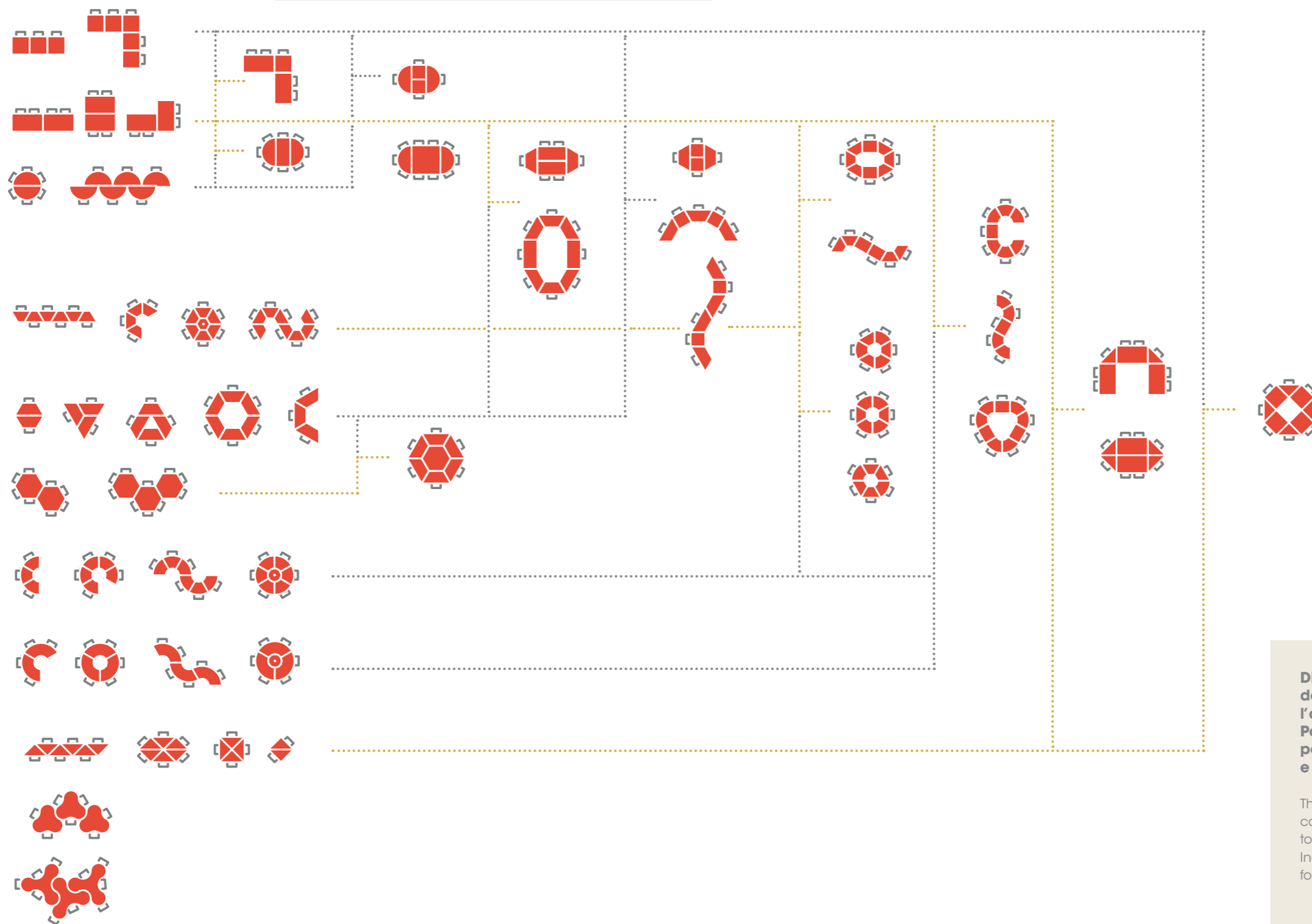

Dimensioni e geometrie dei componenti del sistema sono coordinati per consentire l'accostamento di elementi di forme diverse. Postazioni individuali compongono tavoli per piccoli e grandi gruppi, per riunioni e lavoro cooperativo.

The sizes and shapes of the table system are co-ordinated to allow the creation of arrangements to suit any requirement
Individual elements combine for small and large groups, for meetings and for collaborative work.

POSTAZIONI ERGONOMICHE

per sostenere posture corrette
e mantenerle nel tempo

ERGONOMIC DESKS

for keeping correct posture
over long periods of time



Banchi e sedie con vari dispositivi di regolazione.

Desks and chairs with various adjustment mechanism.



PLANO
PLANO
60x75-130-150 cm

Banco con piano di lavoro fisso, altezza regolabile. Disponibile a uno o due posti, con vari accessori. Disponibile anche con struttura ad altezza fissa.

Desk with fixed worktop and adjustable height legframe. One or two seat versions available, with many accessories. Also available with fixed height structure.



ERGO VARIO
ERGO VARIO
60x75-130-150 cm

Banco con piano di lavoro in parte inclinabile, altezza regolabile. Disponibile a uno o due posti, con vari accessori. Disponibile anche con struttura ad altezza fissa.

Desk with tilting top and adjustable height legframe. One or two seat versions available, with many accessories. Also available with fixed height structure.



ALESU-ALU
ALESU-ALU

Sedia regolabile a tre altezze, con struttura in alluminio e acciaio, seduta e schienale ergonomici in multistrato di faggio.

Chair with three adjustable height settings, aluminium and steel structure, ergonomic beech plywood seat and backrest.



ADAPTO
ADAPTO

Sedia a tre altezze con profondità di seduta regolabile, con struttura in alluminio e acciaio, seduta e schienale ergonomici in multistrato di faggio.

Chair with three adjustable height settings and adjustable seat depth, aluminium and steel structure, ergonomic beech plywood seat and backrest.



GENIO
GENIO
60x75-130 cm

Banco con piano di lavoro fisso, altezza regolabile con manovella rimovibile. Disponibile a uno o due posti, con vari accessori. Disponibile anche con struttura ad altezza fissa.

Desk with fixed worktop, height adjustable by using a removeable handle.

One or two seat versions available, with a range of accessories. Also available with fixed height structure.



GENIO - E
GENIO - E
60x75-130 cm

Banco con piano di lavoro in parte inclinabile, altezza regolabile con manovella rimovibile. Disponibile a uno o due posti, con vari accessori. Disponibile anche con struttura ad altezza fissa.

Desk with partly tilting worktop, height adjustable by using a removeable handle.

One or two seat versions available, with a range of accessories. Also available with fixed height structure.

MATERIALI E COLORI

MATERIALS AND COLOURS

piano di lavoro
table top



struttura metallica
metal structure



Tutti i modelli sono disponibili nelle dimensioni 2, 3, 4, 5, 6, e 7 UNI EN 1729.

All models are available in the following UNI EN 1729 sizes: 2, 3, 4, 5, 6 and 7.

TAVOLI SPECIALI
per insegnare, muoversi, fare spazio

SPECIAL TABLES
for teaching, flexibility, creating space



TAVOLO CON PIANO RIBALTABILE
flip-top table
H 73 70-80x120-140-160-180 cm

Tavolo rettangolare su ruote con piano ribaltabile, per accostamento in poco spazio.

Rectangular table on castors with flip-top, to be stored interlinked in small spaces.

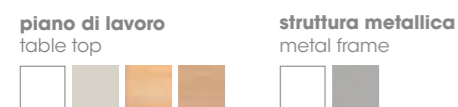

POSTAZIONE INSEGNANTE
teacher's workstation
H 70-110 70x90 cm

Tavolo ad altezza regolabile, su ruote.
Adjustable height table, on castors.



CATTEDRA
teacher's table
H 75 80x140 cm

Tavolo con modesty panel.
Table with modesty panel.



TAVOLO
table
H 75 cm

Tavolo cablabile con piano in nobilitato e struttura metallica.

Table with wire management, MFC top and metal structure.



POSTAZIONE OPAC
opac stations
H 95 63x70 cm

Postazioni OPAC con piano semplice o sagomato, con piantana fissa o ad altezza regolabile.

OPAC stations with plain or shaped top, on fixed or height-adjustable stand.

ACCESSORI
ACCESSORIES



La struttura metallica distaccata dal piano sostiene ganci, cestelli portaogetti, supporti per il cablaggio, porta CPU.

The metal structure supports hooks, trays, cabling outlets, CPU shelf.

DIMENSIONI SIZE	GANCIO PORTAZAINO SCHOOL BAG HOOK	CONTENITORE LATERALE SIDE BASKET	PORTA CPU CPU SHELF
65x65 cm 80x80 cm 130x130 cm	■	■	■
50x70 cm 50x130 cm 65x130 cm	■	■	■
80x120 cm 80x140 cm 80x160 cm 80x180 cm			
D 100 cm D 130 cm			



SEDIE, SGABELLI, SEDUTE
per stare bene, in posizioni idonee,
confortevoli, dinamiche

CHAIRS, STOOLS, SEATS
for sitting with correct,
comfortable and dynamic posture



K-TYPE
K-TYPE

Sedia con monoscocca in poliuretano, disponibile su base a quattro gambe, a slitta e a cinque razze su ruote.

Chair with polyurethane seating shell, available with four legs, cantilever base or five star base on castors.



POSTURA +
POSTURA +

Sedia impilabile, interamente in polipropilene.

Stackable chair, made entirely with polypropylene.



SNOW
SNOW

Sedia impilabile in polipropilene. Disponibile in due altezze: seduta H 45 e H 35 cm.

Stackable polypropylene chair. Available in two seat heights: H 45 and H 35 cm.



STAND.UP
STAND.UP

Sgabello basculante ergonomico, in due altezze regolabili: da cm 37,5 a cm 49 e da cm 45 a cm 63.

Ergonomic tilting stool, height adjustable from cm 37,5 to cm 49 and from cm 45 to cm 63.



TIROL
TIROL

Sgabello impilabile in multistrato di betulla, altezza cm 45.

Stackable birch plywood stool, height cm 45.



TURIN
TURIN

Sgabello con seduta in multistrato e struttura in metallo, ad altezza variabile a vite.

Stool with plywood seat and metal structure, height adjustable.



TALLIN
TALLIN

Sgabello con seduta in multistrato e struttura in metallo, ad altezza variabile.

Stool with plywood seat and metal structure, height adjustable.



FOLLOW ME
FOLLOW ME

Sedia con monoscocca in polipropilene, con tavoletta orbitante e base portaoggetti a 6 ruote.

Chair with polypropylene seating shell, rotating writing tablet and storage tray base on 6 castors.

scocca e portaoggetti
shell and object holder



base basket
basket base



**G-TYPE
LA NUOVA SEDIA GAM**
per scegliere design, ergonomia,
sostenibilità

G-TYPE
THE NEW GAM CHAIR
to choose design, ergonomics,
sustainability



ERGONOMIA
ERGONOMICS

La scocca in polipropilene è disegnata per favorire una postura corretta. La flessibilità della forma e del materiale garantisce il massimo comfort.

The polypropylene shell is designed to promote correct posture. The design and material flexibility guarantees maximum comfort.



G-TYPE su quattro gambe
G-TYPE on four legs

G-TYPE su slitta cantilever
G-TYPE on cantilever base

G-TYPE a cinque razze su ruote
G-TYPE on five-star base on castors

G-TYPE sgabello
G-TYPE stool

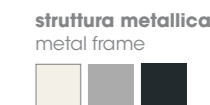

DESIGN
DESIGN

G-Type è la nuova sedia ideata da GAM e prodotta in collaborazione con la capogruppo iMilani. È un progetto originale, sviluppato con il contributo di competenze specialistiche, per trovare la miglior sintesi di estetica, funzionalità, qualità produttiva. G-Type è disponibile in cinque colori e in legno compensato curvato, su quattro gambe, su slitta cantilever e a cinque razze su ruote. I modelli su gambe e slitta sono impilabili. Il design è di Giovanni Fumagalli e Claudio Gorgi.

G-Type is the new chair designed by GAM and produced in collaboration with the parent company iMilani. This peculiar project, developed through specialized skills, aims to find the best synthesis of aesthetics, functionality, production quality. G-Type chair is available in five colours and in curved natural plywood. The base can be on four legs, cantilever or with five castors. The legs and cantilever models are stackable. The design is by Giovanni Fumagalli and Claudio Gorgi.



SOSTENIBILITA'
SUSTAINABILITY

La medesima scocca viene proposta anche in plastica riciclata ed è il risultato della ricerca tecnologica della capogruppo iMilani, azienda leader di mercato e all'avanguardia nell'evoluzione ecologica delle produzioni in materiale plastico. Tutto ciò rappresenta l'impegno di GAM orientato alla sostenibilità e alla tutela dell'ambiente.

The same shell is also offered in recycled plastic and is the result of the technological research by iMilani, market leader company at the forefront of the eco-evolution of plastic products. All this represents GAM's commitment to sustainability and environmental protection.

AULE, SPAZI
DI GRUPPO

CLASSROOMS,
GROUP SPACES

SISTEMA PARETE COMUNICATIVA

per presentare, condividere, insegnare

TEACHING WALL

for presenting, sharing, teaching



Pannelli e lavagne, contenitori, mensole, scrittoi.
Un mosaico di elementi da affiancare ai monitor,
per sostenere comunicazioni di ogni tipo tra studenti
e docenti.

Panels and whiteboards, storage, shelves, writing tops.
A range of elements to be placed next to a multi-function display,
for providing information on various platforms between students
and teachers.

DIMENSIONI

SIZES

Le dimensioni degli elementi del sistema sono coordinate con quelle dei contenitori.
L'altezza complessiva è uguale a quella del contenitore H 168 con sovrapposto
un TOP A CASELLE.

The sizes of the system's elements are coordinated with those of the cabinets.
The overall height is the same as that of the cabinet H 168 with a COMPARTMENT TOP giving
an overall height of 206 cm.

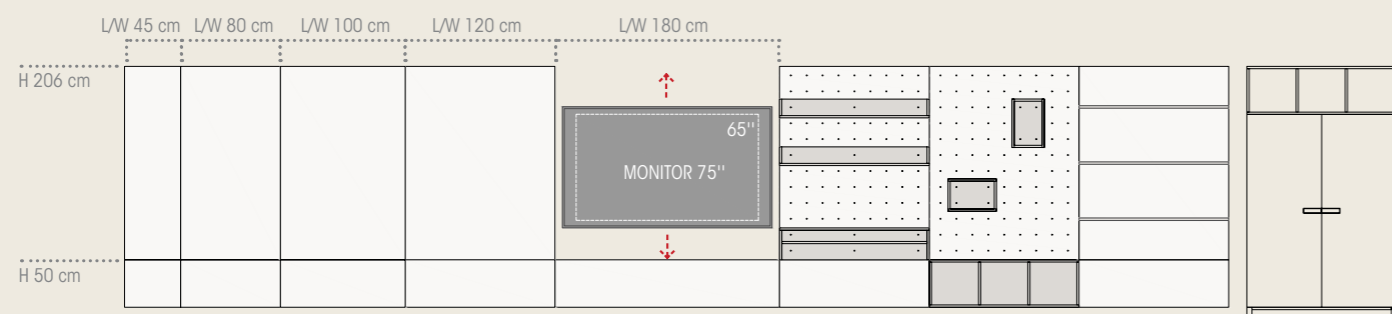

PANNELLI PANELS

**Sono disponibili lisci, con fori o fresature, in sughero,
scrivibili neri o bianchi, magnetici, fonoassorbenti
in molti colori.**

Available plain, with holes or slots, made of cork, whiteboards in
black or white finish, magnetic, acoustic sound absorbing fabric
covered panels in many different colours.

SCATOLA BOX

H 26 25x39 cm

**Può essere utilizzata in orizzontale
e in verticale.**

It can be used horizontally or vertically.

MATERIALI E COLORI

MATERIALS AND COLOURS

**La gamma di colori per strutture
metalliche e piani è coordinata
con quella del sistema dei contenitori.**

The colours for metal structures and tops
are co-ordinated with those of the cabinets.



L/W 45 cm L/W 80 cm L/W 100 cm L/W 120 cm L/W 180 cm



PANNELLO A PARETE wall panel

H 156 cm



PANNELLO A PARETE wall panel

H 38 cm



MENSOLA shelf

H 15 P/D 25 cm



SCRITTOIO writing top

H 26 P/D 43 cm



CONTENITORE A CASELLE compartment top

H 38 P/D 45 cm



FARE

e disfare, imparare con le mani

MAKING

and unmaking, learning using the hands

Falegnamerie, officine, makerspace ampliano i modi dell'apprendimento. La scuola è anche laboratorio che avvicina pensiero e attività pratiche. Banchi da lavoro, carrelli, lavagne, scaffali per utensili manuali e attrezzature meccaniche arredano luoghi dove progettare e realizzare artefatti.

Carpentry shops, workshops, makerspaces expand the learning methods. The school is also a workshop that brings theory closer to practical activities. Work tables, trolleys, writing boards, racks for manual tools and mechanical equipment furnish areas dedicated to design and craft activities





ESPLORARE

nuove possibilità e nuove tecnologie

EXPLORING

new possibilities and new technologies

Laboratori per coding, robotica e tinkering svelano nuove opportunità. Dalla scuola primaria alle superiori, elettronica e informatica prendono le forme del gioco o di prove più complesse. Tavoli da lavoro o per piccoli robot, postazioni informatiche, carrelli, scaffalature arredano ambienti che sostengono ingegnosità e ricerca.

Coding, robotics and tinkering workshops offer new learning opportunities. From primary to secondary school, electronics and computer science take on the shape of games or of more complex experimentation. Tables for work or for small robots, computer stations, trolleys and racking furnish areas dedicated to creativity and research.





CREARE

disegni, composizioni, progetti

CREATING

drawings, compositions, projects

Atelier, laboratori di grafica e d'arte, studi di design promuovono la creatività. Arredi e strumenti tradizionali e nuovi si integrano in ambienti dove sperimentare tecniche tradizionali e nuove. Cavalletti, tavoli da disegno, tavoli luminosi, cassettiere pannelli a parete allestiscono spazi di produzione e esposizione.

Ateliers, graphics, art and design workshops promote creativity. Traditional and new furnishings and instruments come together in areas where traditional and new techniques can be experimented with. Easels, drafting tables, light tables, drawer units and wall panels furnish areas for making and displaying



ARREDI PER SPAZI DI MANIFATTURA

per attrezzare falegnamerie, officine,
makerspace

FURNISHING FOR MANUFACTURING SPACES

for equipping carpentry shops,
workshops, makerspaces



piano di lavoro
table top

acero
maple

struttura metallica
metal structure



BANCO DA LAVORO
work table
H 76 cm



75X150 cm
75X200 cm

BANCO DA LAVORO ALTO
high work table
H 90 cm



75X150 cm
75X200 cm

**BANCO DA LAVORO
CON SOPRALZO**
work table with pegboard riser
H 76/206 cm



75X150 cm
75X200 cm

**BANCO DA LAVORO ALTO
CON SOPRALZO**
high work table with pegboard riser
H 90/206 cm



75X150 cm
75X200 cm

PANNELLO A PARETE
wall panel
H 100 cm



50 cm
100 cm
150 cm

MENSOLA
shelf
H 18 P/D 32 cm



142 cm
192 cm



CARRELLO PER ATTREZZI
tool trolley
H 156,5 43x102,5 cm

Carrello metallico con sopralzo per cassette
e cassette in plastica di varie dimensioni.

Metal trolley with pegboard riser for plastic
boxes and trays of varying sizes.



CARRELLO A 3 CASSETTI
trolley with 3 basket drawers
H 117 56x76 cm

Carrello leggero in tubolare d'acciaio,
completo di 3 cassette in plastica.

Light steel tubular trolley, complete
with 3 plastic trays.



BANCO FALEGNAMERIA
carpentry workbench
H 86 61x148 cm

Banco in legno massello, con cassetto
e morsa a vite.

Solid wood workbench with drawer and screw vice



SCAFFALE
SHELF

Scaffale modulare in acciaio verniciato,
ad alta portata, per riporre strumenti e lavori.
Disponibile in varie altezze e profondità.

Heavy duty, modular shelving in painted steel.
Various heights and depths available.

ARREDI PER SPAZI DI SPERIMENTAZIONE

per inventare laboratori per coding,
robotica, tinkering

FURNISHING FOR EXPERIMENTATION SPACES

for inventing, coding, robotics and
tinkering workshops



CARRELLO LAVAGNA
writing board trolley
H 143 43,5x68,5 cm

Carrello metallico con 2 pannelli
bianchi scrivibili e 4 cassetti.

Metal trolley with two whiteboard
surfaces and 4 trays.



CARRELLO A CASSETTI
trolley with trays
H 88,5 43,5x68,5 cm

Carrello con 8 cassetti bassi
e 4 cassetti alti.

Trolley with 8 shallow trays
and 4 deep trays.

CASSETTI

TRAYS

H 7,5-15 43x31,2 cm

Cassetti in materiale plastico
trasparente o colorato.

Made of clear or coloured plastic.



TAVOLO PER CODING

CODING TABLE

Tavolo quadrato con sponde e piano bianco scrivibile.
La sponda di un lato è amovibile per accoppiare due tavoli.
È disponibile con struttura metallica su ruote o gambe in legno.

Square table with raised edges and white writeable top.
The edge along one side can be removed to join two tables together.
Available with metal structure on castors or wooden legs.



TAVOLO PER CODING
struttura metallica su due ruote
coding table
metal structure on two castors
H 90 130x130 cm



TAVOLO PER CODING
gambe in legno
coding table
wooden legs
H 90 130x130 cm



TAVOLO PER CODING BASSO
gambe in legno
low coding table
wooden legs
H 38 130x130 cm



TAVOLO PER TINKERING
struttura metallica su due ruote
tinkering table
metal structure on two castors
H 90 130x130 cm



TAVOLO PER TINKERING
gambe in legno
tinkering table
wooden legs
H 90 130x130 cm



ARREDI PER SPAZI DI CREATIVITA'

per allestire atelier,
laboratori di grafica e di arte

FURNISHING FOR CREATIVITY SPACES

for setting up ateliers,
graphics and art studios



CAVALLETTO
easel
H 161 75x75 cm

Cavalletto contenitore su ruote.
Disponibile in multistrato di betulla o bianco.

Easel on casters with integral shelf
Available in birch or white plywood.



TAVOLO SU CAVALLETTI
table on trestles
H 75 80x220 cm

Tavolo in legno multistrato su cavalletti regolabili in altezza.

Plywood table on height-adjustable trestles.



TAVOLO DA DISEGNO
drafting table
H 70-90 80x120 cm

Tavolo con struttura metallica e piano inclinabile con fermo a vite.

Table with metal structure and tilting top with screw locking mechanism.



CARRELLO PER ACQUERELLI
trolley for watercolours
H 94,5 51x57 cm

Carrello porta griglie per acquerelli.

Trolley with wire trays for paintings.



CARRELLO PER ACQUERELLI E CARTA
trolley for watercolours and paper
H 94,5 51x57 cm

Carrello porta griglie per acquerelli, con 4 cassetti.

Trolley with wire trays for paintings and 4 plastic trays.



CASSETTIERA
plan chest
H 94,5 75x116 cm

Cassettiera metallica con dieci grandi cassetti porta disegni.

Metal drawer unit with ten large drawers for storing drawings.



TAVOLO LUMINOSO
struttura metallica su due ruote
light table
metal structure on two castors
H 90 130x130 cm



TAVOLO LUMINOSO
gambe in legno
light table
wooden legs
H 90 130x130 cm



TAVOLO LUMINOSO BASSO
gambe in legno
low light table
wooden legs
H 38 130x130 cm

TAVOLO LUMINOSO LIGHT TABLE

Tavolo quadrato luminoso.
È disponibile con struttura metallica su due ruote o gambe in legno.

Square light table.
Available with metal structure on castors or wooden legs.

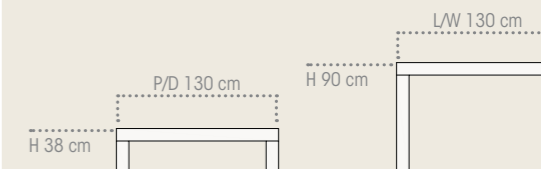

**ARREDI PER SPAZI
DI INFORMATICA**
per usare bene dispositivi digitali

FURNISHING FOR IT SPACES
for using digital devices correctly



CASSETTO CARICA TABLET
tablet charging drawer
H 15 43x31,2 cm

Cassetto per conservare e caricare 10 tablet.
Disponibile in due profondità.

Drawer for holding and charging up to 10 tablets.
Available in two different depths.



CARRELLO CARICA NOTEBOOK
notebook charging trolley
H 95 55x65 cm

**Armadio su ruote per conservare, ricaricare
e trasportare 16 notebook con schermi fino
a 15,6". Le ante sono chiudibili a chiave.**

Trolley on castors for holding, charging and transporting up
to 16 notebooks with screens up to 15.6". The doors can be
locked.



PLOTTER DA TAGLIO
PLOTTER DA TAGLIO

Plotter da taglio con software CutStudio.

Cutting plotter with CutStudio software.



FOCUS 3D
FOCUS 3D

Stampante 3D da utilizzare per alimenti.

Food 3D printer.



LASERBOX
LASERBOX

**Grazie a una videocamera grandangolare ad alta
definizione e a un algoritmo visivo di intelligenza
artificiale, LaserBox identifica il materiale
e imposta automaticamente i parametri.**

Thanks to a HD wide-angle camera and an AI visual
algorithm, LaserBox detects the material and automatically
sets the calculation parameters.

LEGO EDUCATION SPIKE PRIME
LEGO EDUCATION SPIKE PRIME

**Set di robotica educativa per introdurre
alle materie STEM.
Indicato per la secondaria di primo grado,
oltre che per gli ultimi anni della primaria
e i primi del ciclo superiore.**

Educational robotics set to introduce STEM subjects.
Suitable for 6-8 grade students.



CARRELLONE LABORATORIO STEM SU RUOTE

per tecnologie disponibili ovunque

CARRELLONE STEM LABORATORY TROLLEY ON WHEELS

for technologies available everywhere



Carrellone è un laboratorio mobile, facile da spostare, che può passare facilmente da uno spazio all'altro. Anche da un piano all'altro utilizzando l'ascensore. Dinamico e flessibile, porta l'esperienza STEM in tutta la scuola.

Carrellone is a mobile laboratory that can easily be moved from one space to another, even from one floor to another by the elevator. It brings the STEM experience throughout the school.

DESIGN DESIGN

Carrellone richiama gli antichi baui utilizzati nei viaggi transatlantici. Si apre e si chiude. I pannelli di chiusura diventano piani di appoggio. Il design è di Francesco Bombardi.

Carrellone recalls the ancient trunks used in transatlantic travels. It opens and closes. The closing panels become support surfaces. Designed by Francesco Bombardi.

DOTAZIONE TECNOLOGICA IT EQUIPMENT

I vani di carrellone sono progettati per contenere una ricca dotazione tecnologica: stampante 3D, lasercut, proiettore, luci led, lavagna scrivibile, cassettiere per componenti di robotica, utensili di chimica.

Carrellone compartments are designed to contain a rich set of IT equipment: 3D printer, lasercut, projector, LED lights, writable whiteboard, drawers for robotics components, chemistry tools.

TERMOFORMATRICE
thermoforming machine



STAMPANTE 3D
3D printer



PROIETTORE
projector



KIT MAGNETISMO
magnetism kit



KIT ENERGIA
energy kit



KIT SUONO
sound kit



KIT ARIA E ACQUA
air & water kit



KIT LUCE E COLORE
light & colour kit





NUTRIRSI

di conoscenza reciproca

NOURISHING

friendship

Il pranzo è un momento prezioso di incontro conviviale. Nella mensa gruppi di studenti trovano ambiti vari e caratterizzati. Composizioni diverse di tavoli e sedie, contenitori e pannelli per la buona acustica arredano un ambiente accogliente e confortevole.

Lunchtime is a time of conviviality. In the cafeteria, groups of students find a relaxing environment in which to eat. Different layouts of tables, chairs, cabinets and acoustic panels furnish a welcoming and comfortable area.





CONDIVIDERE

lo spazio del pranzo come luogo
della comunità scolastica

SHARING

the dining space
as a school community area

**La mensa è un ambiente polifunzionale.
Oltre il tempo del pranzo è uno spazio di incontro, di studio, di lavoro.
Arredi componibili, vari e leggeri si dispongono in configurazioni
adatte ad attività diverse.**

The cafeteria is a multifunctional space.
In addition to the time spent for eating, it is a place for meeting, studying,
working and group activity.
Modula and light furniture elements are arranged in layouts suitable
for several uses.

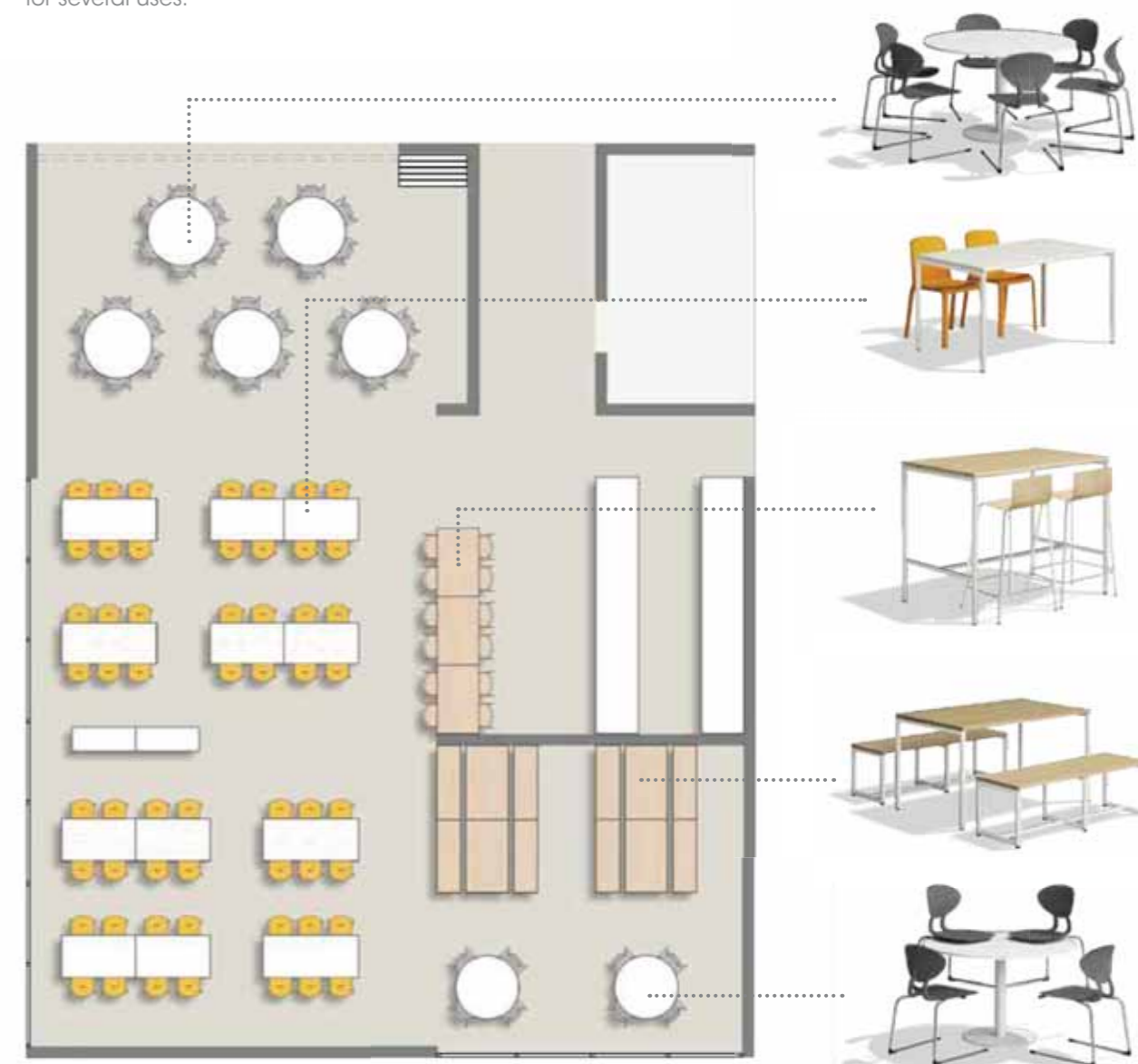

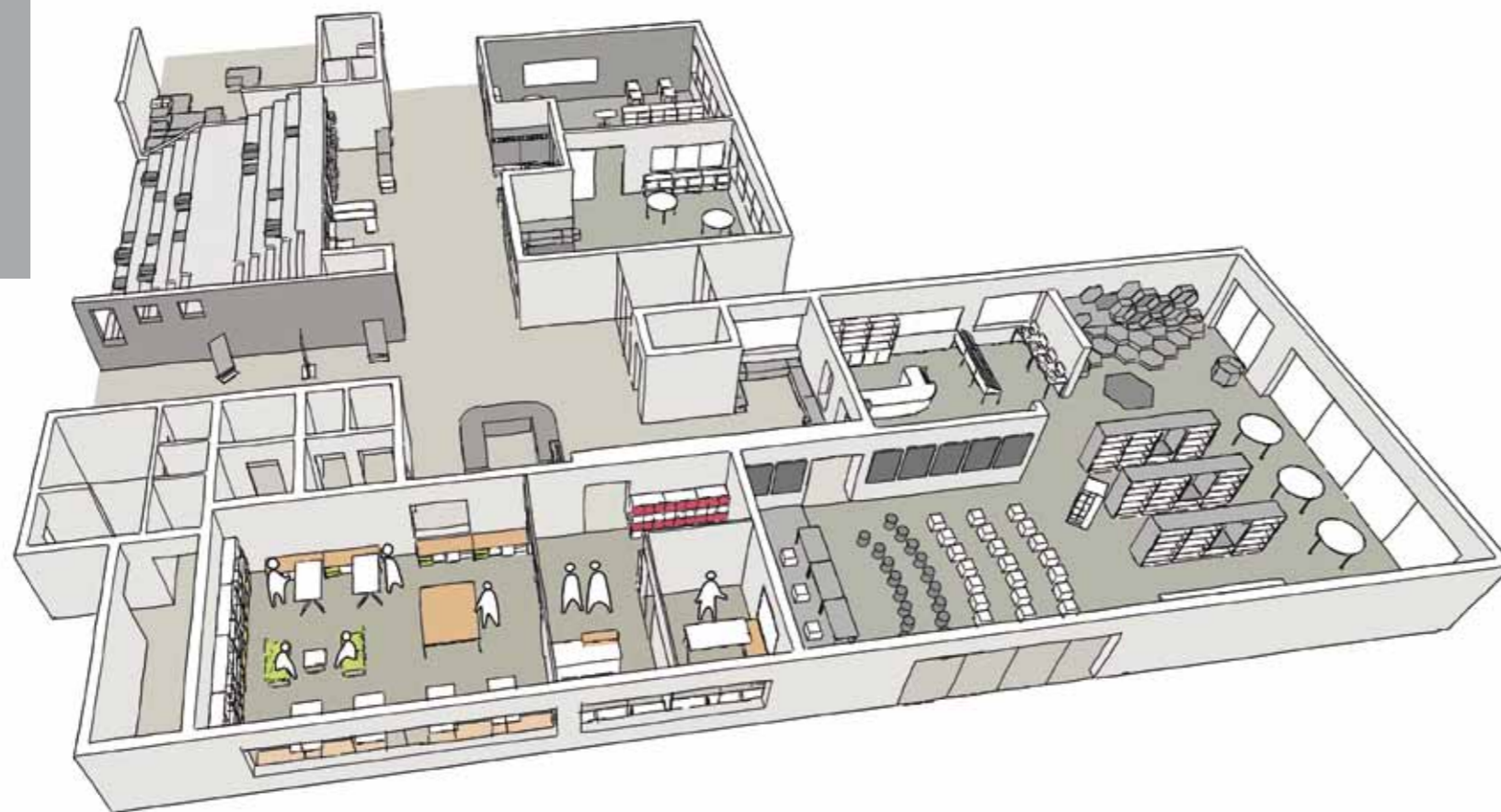

COORDINARE

programmi, attività, incontri, lezioni

CO-ORDINATING

programs, activities, meetings, lessons

Gli ambienti dei docenti sono funzionali e confortevoli. Ambiti individuali e di riunione favoriscono momenti di studio e attività organizzative. Scrivanie, contenitori personali, grandi tavoli, scaffali, sedute informali arredano la cabina di regia della scuola.

The teachers' spaces need to be functional and comfortable. Individual and group arrangements encourage study and organisational activities. Desks, personal storage, large tables, shelves and informal seating furnish the staff areas.



CONSULTARE

ricerche, manuali, saggi, testi letterari

CONSULTING

papers, manuals, essays, literature

**La biblioteca è un luogo antico e contemporaneo.
Si ritrovano il fascino della conservazione del sapere e lo sguardo
aggiornato ai nuovi supporti della conoscenza.
Scaffali, tavoli, sedute leggere aggregabili e impilabili compongono
ambiti di lettura, di studio, per presentazioni e conferenze.**

The library is an ancient and contemporary place.
It brings together the traditional knowledge conservation
and new information streams using state of the art technology.
Shelving, tables and seating are organised into reading, studying,
presentation and conference areas suitable for the modern library
environment.



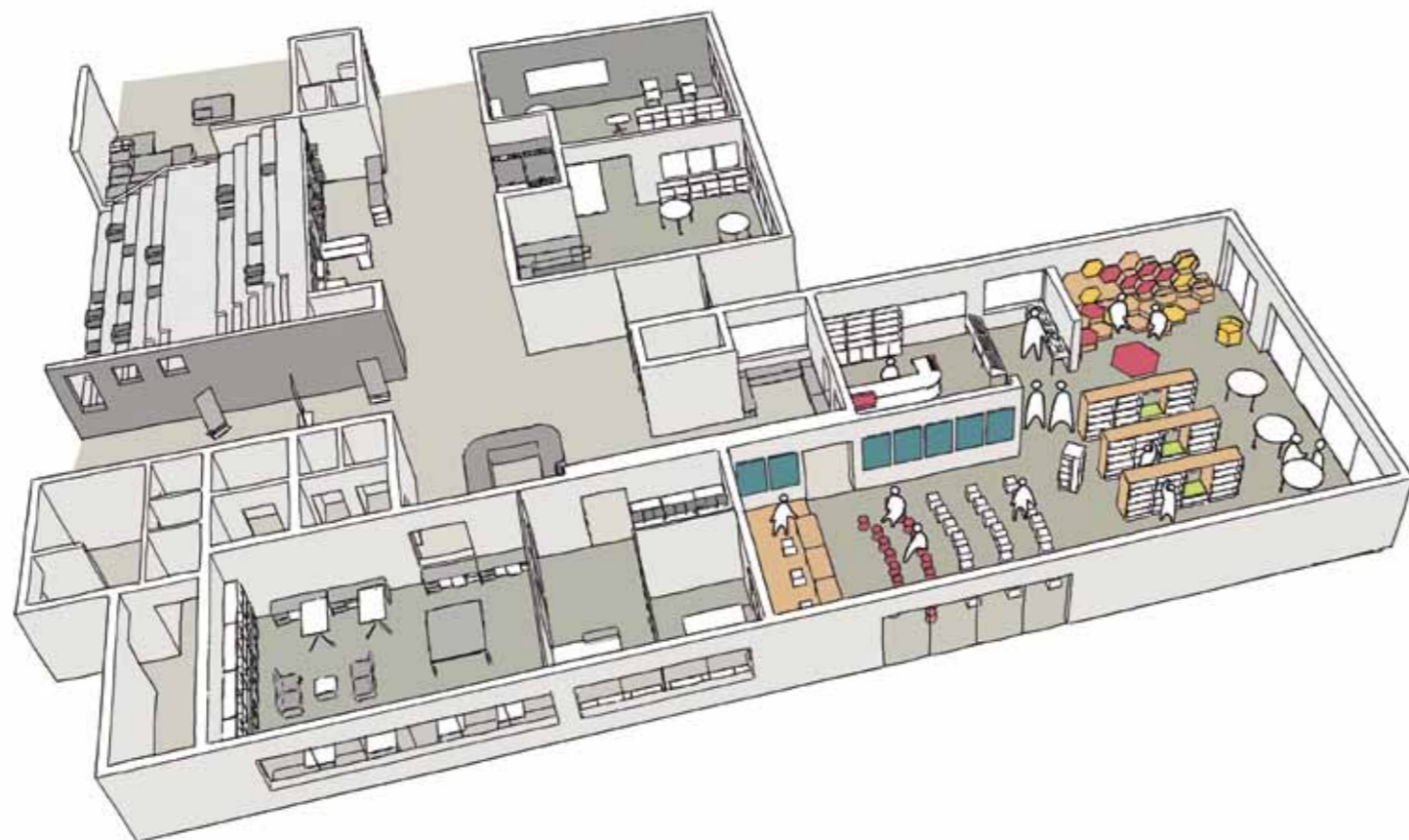

LEGGERE

seduti per terra, sdraiati, a testa in giù.

READING

while sitting, lying, or upside down

La biblioteca è anche giocosa.
Ambiti informali invitano a un rapporto amichevole con i libri e i dispositivi digitali.
Pedane, sedute morbide, tappeti arredano spazi adatti non solo ai più giovani.

The library can also be a fun place.
Informal environments lead to an easy rapport with books and digital devices.
Platforms, soft seating, carpets decorate spaces suitable for everyone.

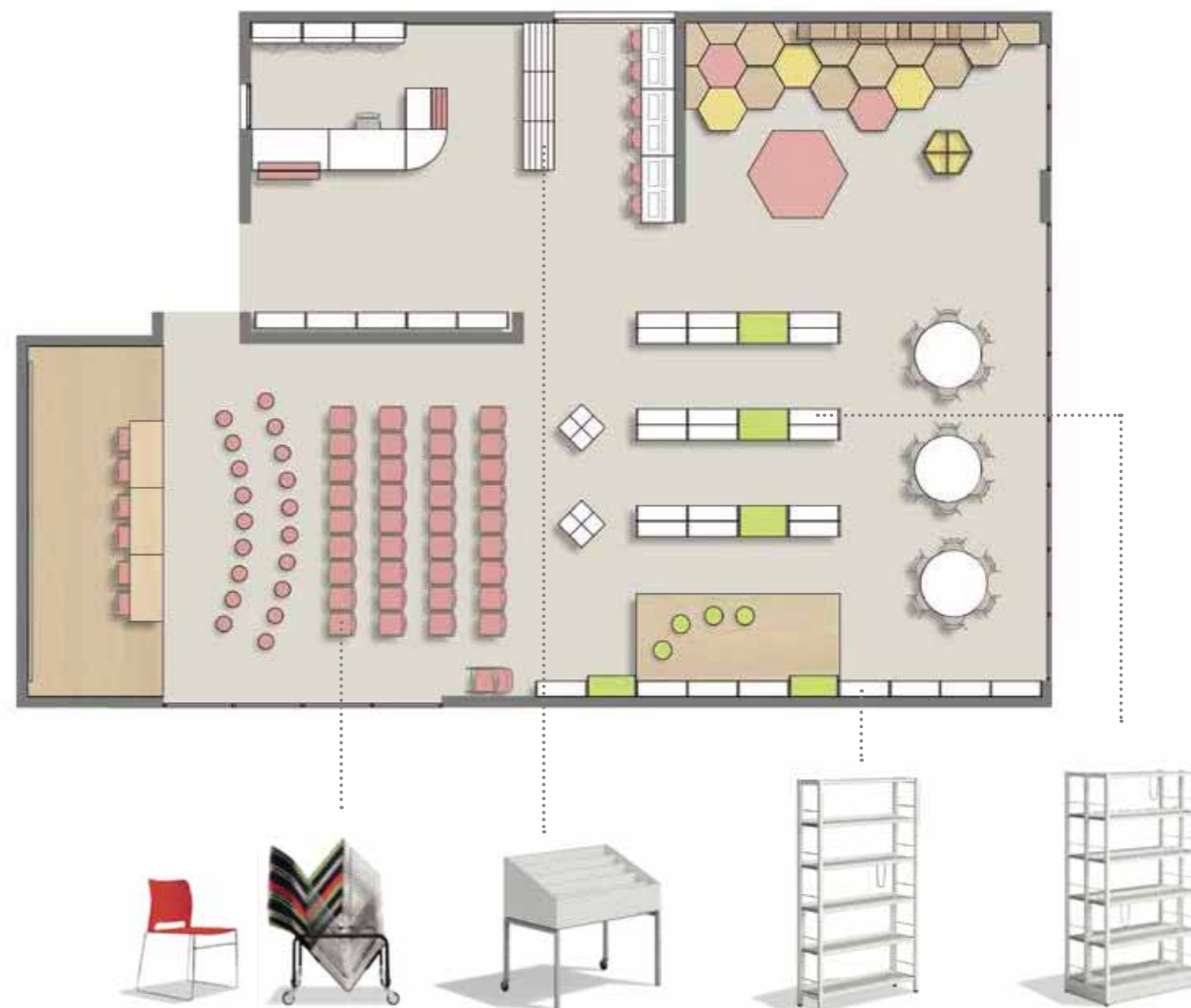

SCRIVANIE, POSTAZIONI DI LAVORO

per arredare studi dei docenti
e segreterie

DESKS, WORK STATIONS
for teachers' rooms and
administration offices



Linee di arredi per ufficio sono dedicate al lavoro
individuale e di gruppo degli insegnanti e alla gestione
della scuola.

Office furniture designed for individual and group work of teaching
staff and for school management.



TAVOLO SMART
SMART TABLE

Tavoli individuali e aggregabili di disegno
minimale.
Il piano è distaccato dalle gambe metalliche.
Il sistema è cablabile.

Individual and modular tables featuring minimal design.
The top is detached from the metal frame.
The system can be wire managed.

struttura metallica
metal structure



TAVOLO UFFICIO
office desk
H 75 P/D 80 cm



120x80 cm
140x80 cm
160x80 cm
180x80 cm
200x80 cm

TAVOLO UFFICIO DOPPIO
double office desk
H 75 P/D 163 cm



120x163 cm
140x163 cm
160x163 cm
180x163 cm
200x163 cm

TAVOLO AGGREGATO
side extension
H 75 P/D 60 cm



100x60 cm
120x60 cm

TAVOLO CONFERENZA
conference table
H 75 P/D 123 cm



200x123 cm

POSTAZIONE VISTA
VISTA STATION



Tavoli individuali e aggregabili di disegno originale.
Gli elementi asimmetrici del cavalletto si compongono
per piani di tre diverse profondità.
Il sistema è cablabile.

Individual and modular tables with an original design.
The asymmetrical elements of the trestle can support tops
in three different depths.
The system can be wire managed.



TAVOLO CAVALLETTO STRETTO
narrow trestle table
H 75 P/D 60 cm



120x60 cm
140x60 cm
160x60 cm
180x60 cm

TAVOLO CAVALLETTO MEDIO
intermediate trestle table
H 75 P/D 80 cm



140x80 cm
160x80 cm
180x80 cm

TAVOLO CAVALLETTO LARGO
wide trestle table
H 75 P/D 100 cm



140x100 cm
160x100 cm
180x100 cm

CONTENITORE
cabinet
H 62 P/D 55 cm



138x55 cm
168x55 cm

CONTENITORE LATERALE
side cabinet
H 75 80X40 cm



PANNELLO DIVISORIO
partition
H 35-55 cm



L 120 cm
L 140 cm
L 160 cm
L 180 cm



TAVOLO UP
UP TABLE

Tavolo motorizzato ad altezza regolabile
da 65 a 125 cm.
Disponibile mono e bifronte, con numerosi
accessori.

Electrically operated, height adjustable
from 65 to 125 cm.
Available with single or face-to-face workstations,
with a wide range of accessories.



120x80 cm
140x80 cm
160x80 cm
180x80 cm



120x164 cm
140x164 cm
160x164 cm
180x164 cm

LIBRERIE, CONTENITORI, CASELLARI

per allestire gli uffici della scuola

BOOKCASES, CABINETS, FILE STORAGE SYSTEM

for school offices



Sistema componibile per realizzare librerie a parete e divisori in open space. Scaffalature essenziali si completano e personalizzano con schienali e contenitori da inserire liberamente nei vani a giorno.

Modular system for creating wall bookcases and partitions in open spaces. Open shelving units are customised by means of backing panels and cabinets to be inserted in open compartments.

MATERIALI E COLORI

MATERIALS AND COLOURS

Due gamme di finiture per gli scaffali INSERT e per gli elementi FILL consentono di realizzare composizioni molto varie.

Two ranges of finishes for the INSERT bookcase and for the FILL elements allow a wide range of attractive finishes to the storage solution.

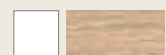

accessori
accessories

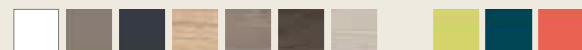

SCAFFALE INSERT
INSERT bookcase
H 197 169x40 cm



SCHIENALE
back
H 45 L/W 80 cm



ELEMENTI FILL

FILL ELEMENTS

Casettiere e contenitori a giorno e chiusi ad ante si inseriscono nei vani degli scaffali INSERT. Si realizzano composizioni che alternano vani aperti e chiusi, colori e materiali diversi.

Drawer units and cabinets can be inserted into the compartments of the INSERT bookcase. Arrangements with open and closed compartments and with different colours and materials can be made.

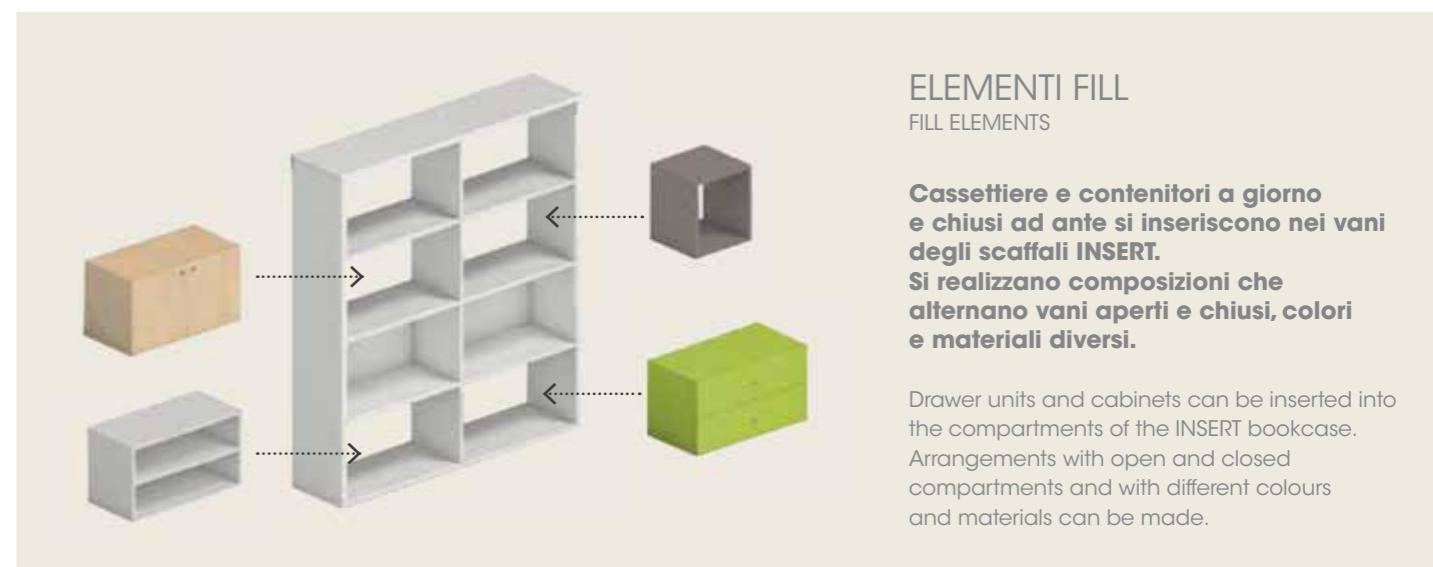

L/W 40 cm

L/W 80 cm

BOX FILL
FILL box
H 45 P/D 38 cm



CONTENITORE A GIORNO FILL
FILL open cabinet
H 45 P/D 40 cm



CASSETTIERA FILL
FILL drawer unit
H 45 P/D 40 cm



CONTENITORE CON ANTE FILL
FILL cabinet with doors
H 45 P/D 40 cm



SISTEMA DI SCAFFALI MODULAR

per consultare, catalogare, proporre

MODULAR SHELVING SYSTEM

for consulting, cataloguing, proposing



Un sistema completo che porta nelle scuole l'esperienza maturata in grandi biblioteche. Scaffali metallici mono e bifronte. I moduli bifronte sono disponibili anche su ruote.

A complete system that brings to schools the experience developed in large scale libraries. Single and double sided shelving units. The double sided modules are also available on castors.

DIMENSIONI SIZES

Il sistema MODULAR comprende moduli di varie larghezze, altezze e profondità per adattarsi a ogni ambiente.

The MODULAR system includes modules of various heights, widths and depths that provide a solution for any shelving requirement.

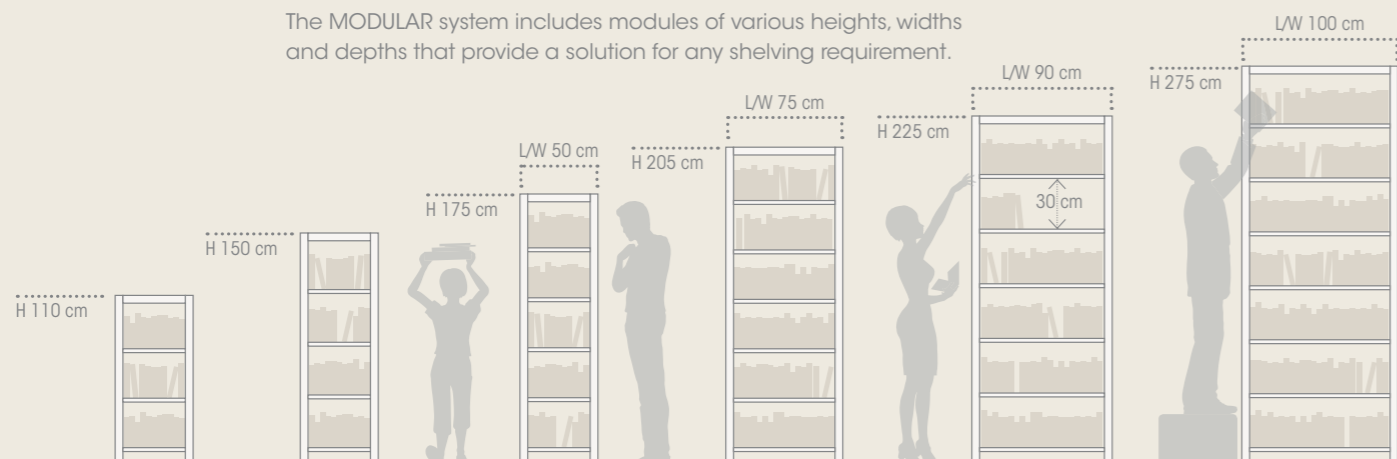

Gli scaffali MODULAR possono essere rivestiti con fianchi e top e anche essere completamente chiusi con ante cieche o vetrate.

The MODULAR shelves can be fitted with side panels, tops, wooden or glass doors.



ACCESSORI ACCESSORIES

Ripiani per i fianchi, box per riviste, cassetti per supporti multimediali, fermalibri: un'ampia gamma di accessori rende gli scaffali MODULAR adatti a soddisfare ogni esigenza della biblioteca.

Add-on shelves for the sides, magazine boxes, drawers for multimedia and book supports provide a wide range of accessories capable of meeting all library requirements.



LETTURA IN NICCHIA READING NICHE

Nei moduli bifronte possono essere inseriti vani in legno con sedute morbide.

Wooden compartments with soft seating can be inserted in the double-sided modules.

ARREDI PER BIBLIOTECA
per esporre, ordinare, disordinare

LIBRARY FURNISHINGS
for displaying and storing



Espositori per libri e supporti multimediali, a schedario e a scalare, in legno e con struttura metallica, ampliano la funzionalità del sistema MODULAR.

Box and tiered displays for books and multimedia, made of wood and metal structure, complement the functional range of the MODULAR system.



CARRELLI PORTALIBRI
book trolleys

Carrelli con struttura in metallo agevolano lo spostamento di libri nelle biblioteche più grandi.

Metal structure trolleys help to move books around libraries.

MATERIALI E COLORI
MATERIALS AND COLOURS

Una gamma di colori per strutture metalliche e piani consente accostamenti cromatici coordinati di scaffali, espositori, carrelli, accessori.

A range of colours for metal structures and tops allow co-ordinated finishes with shelves, displays, trolleys and accessories.

struttura metallica
metal structure



ESAGONI
HEXAGONS

Geometria essenziale per composizioni aperte e versatili. Sistema di pedane, sedute, contenitori e pannelli che realizza ambiti informali, non solo in biblioteca.

Geometrical units for open and versatile arrangements. A system of platforms, seats, displays and panels to create informal spaces not only in the library.



morbidi
soft furnishing



PANNELLI A PARETE
wall panel
H 85 L/W 83-96 cm



ESPOSITORE A PARETE O ORIZZONTALE
wall or horizontal display
H 24/32 L/W 83-96 cm



ESPOSITORE ORIZZONTALE ALTO
high horizontal display
H 48/56/64 L/W 83-96 cm



PEDANA TRAPEZIOIDALE
trapezoidal platform
H 16/24/32/48
L/W 41,5-96 cm



H 19 cm
H 38 cm

PEDANA ESAGONALE
hexagonal platform
H 16/24/32/48
L/W 83-96 cm



H 19 cm
H 38 cm

CUSCINO ESAGONALE
hexagonal cushion
H 8 L/W 83-96 cm



SEDUTA MORBIDA TRAPEZIOIDALE
trapezoidal soft seating
H 32/46 L/W 41,5-96 cm



SEDUTA MORBIDA ESAGONALE
hexagonal soft seating
H 32/46 L/W 83-96 cm



TAPPETO ESAGONALE
hexagonal carpet
L/W 83-96 cm



**SEDIE OPERATIVE,
IMPILABILI, MULTIUSO**
per lavorare, riunirsi, pranzare

TASK, STACKABLE,
MULTIPURPOSE CHAIRS
for working, meeting, eating together



RELIEF
RELIEF

Sedia monoscocca in polipropilene.
Disponibile a 4 gambe con braccioli, a slitta, su ruote con altezza regolabile.

Polypropylene monocoque chair.
Available with 4 legs and armrests, cantilever base or on castors and adjustable height.



SGAB-L
SGAB-L

Sgabello con scocca in legno multistrato e telaio in acciaio verniciato.

Stool with plywood seating shell and painted steel frame.

REDONDA
REDONDA



Sedia impilabile con sedile e schienale in polipropilene e telaio in acciaio cromato o verniciato nero o bianco.
Disponibile a 4 gambe o a slitta, con e senza braccioli e con tavoletta scrittoio. La versione a slitta è disponibile anche con aggancio laterale.

Stackable chair with polypropylene seat and back and chrome-plated, black or white painted steel frame.
Available with 4 legs or skid base, with or without armrests and with optional writing tablet. The skid base version is also available with linking device.



KYTON
KYTON

Poltroncina operativa con schienale in rete nera o grigia regolabile in altezza e inclinabile.
Disponibile senza braccioli o con braccioli fissi o regolabili.

Height adjustable task chair with tilting black or grey mesh backrest.
Available without armrests or with fixed or adjustable armrests.



KUBIX
KUBIX

Poltroncina operativa con schienale regolabile in altezza e inclinabile.
Disponibile senza braccioli o con braccioli fissi o regolabili.

Height adjustable task chair with tilting backrest.
Available without armrests or with fixed or adjustable armrests.

**PANNELLI
FONOASSORBENTI**
per sentire bene, per parlare piano

ACOUSTIC PANELS
for hearing well and speaking softly

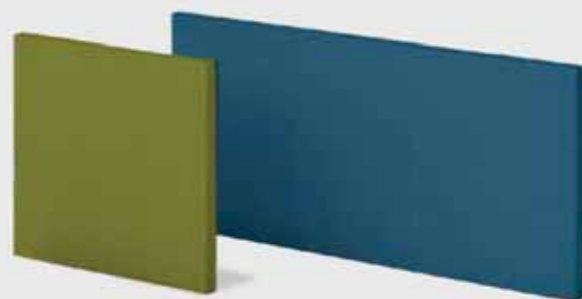
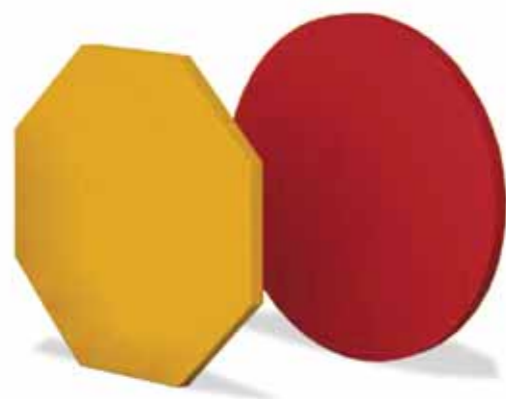

La riduzione del riverbero acustico è essenziale per il comfort degli ambienti.

The dampening of sound is essential to ensure comfortable living space.

PANNELLO SOLUTION
SOLUTION PANEL



Pannelli Phonolook con spigoli ad angolo vivo, rivestiti in tessuto ignifugo.

Phonolook panels with square edge detail, covered in fireproof fabric.

PANNELLO DESIGN
DESIGN PANEL

Pannelli Phonolook bifacciali con finitura perimetrale, rivestiti in tessuto ignifugo.

Double-face Phonolook panels with finished edges, covered in fireproof fabric.

	SOLUTION spessore 30-50 mm	DESIGN spessore 50 mm
	60x60 cm 120x120 cm	60x60 cm 120x120 cm
	60x120 cm 60x180 cm 120x180 cm	20x120 cm 20x180 cm 30x120 cm 30x180 cm 60x120 cm 60x180 cm
	23 cm lato 38 cm lato	23 cm lato 38 cm lato
	d60 cm d100 cm	d60 cm d100 cm

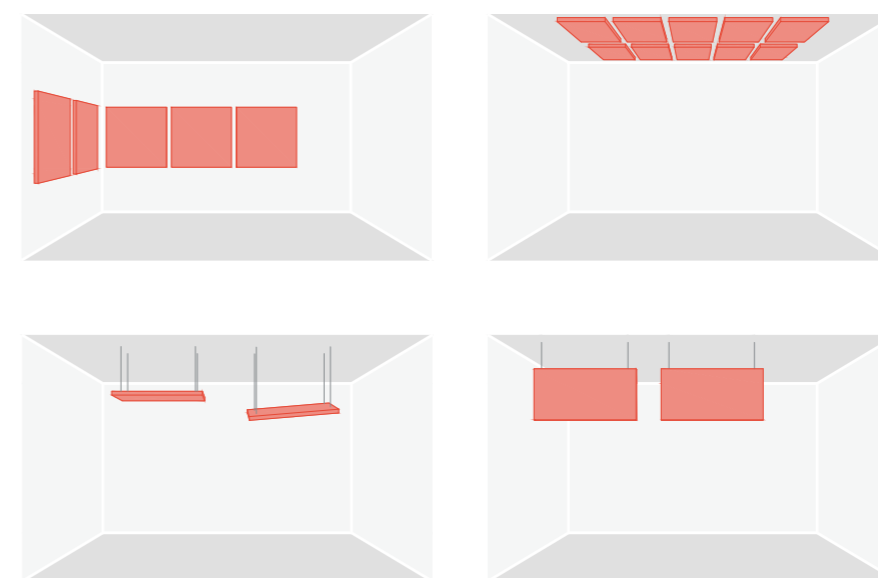

APPLICAZIONI
APPLICATIONS

Tutti i pannelli possono essere montati in aderenza a parete o soffitto oppure sospesi in orizzontale.
I pannelli DESIGN possono essere montati anche sospesi in verticale.

All panels may be attached to the wall or ceiling or may be suspended horizontally. DESIGN panels may also be suspended vertically.

COMPOSIZIONI
ARRANGEMENTS

Poche geometrie e molti colori permettono infinite composizioni. Semplici superfici, fasce, pattern grafici, disegni originali o citazioni da scoprire.

With a few geometric shapes and with many different colours the panels allow for an infinite number of attractive arrangements. Simple surfaces, strips, graphic patterns, original designs or others waiting to be discovered.

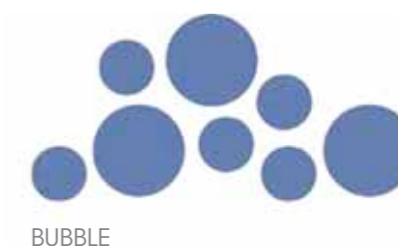



GAM SCUOLE
GAM SCHOOLS

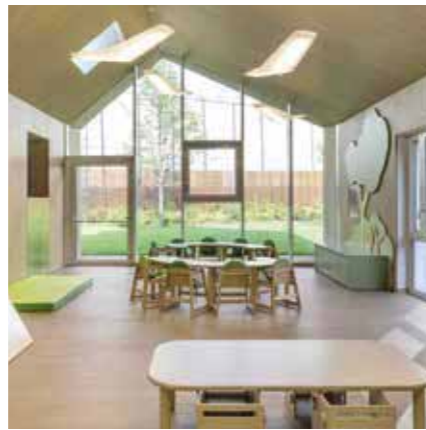

GAM è anche NIDI E SCUOLE D'INFANZIA
GAM also means NURSERIES
AND KINDERGARTENS



GAM è anche BIBLIOTECHE
GAM also means LIBRARIES



DESIGN GAM
GAM DESIGN



CERTIFICAZIONI
CERTIFICATIONS



GAM SCUOLE

GAM SCHOOLS



**Scuola secondaria di secondo grado
A.M. Agnoletti a Sesto Fiorentino, Firenze**

Secondary school
A.M. Agnoletti in Sesto Fiorentino, Florence

GAM SCUOLE

GAM SCHOOLS



**Scuola secondaria di secondo grado
A.M. Agnoletti a Sesto Fiorentino, Firenze**

Secondary school
A.M. Agnoletti in Sesto Fiorentino, Florence

GAM SCUOLE

GAM SCHOOLS



**Scuola primaria
H-Farm Campus a Roncade, Treviso**

Primary school
H-Farm Campus in Roncade, Treviso

GAM SCUOLE

GAM SCHOOLS



**Scuola primaria
H-Farm Campus a Roncade, Treviso**

Primary school
H-Farm Campus in Roncade, Treviso

GAM SCUOLE GAM SCHOOLS



**Scuola secondaria di primo grado
Giovanni Pascoli a Torino**

**Progetto vincitore del concorso d'architettura
"Torino fa scuola", promosso da Fondazione Agnelli
e Compagnia di San Paolo con Città di Torino
e Fondazione per la scuola.**

Courtesy Compagnia di San Paolo/A. Guermani

**Secondary school
Giovanni Pascoli in Turin**

**This project was awarded the "Torino fa scuola"
architectural competition promoted by Fondazione Agnelli
and Compagnia di San Paolo together with the City of Turin
and Fondazione per la scuola.**

Courtesy Compagnia di San Paolo/A. Guermani

GAM SCUOLE

GAM SCHOOLS

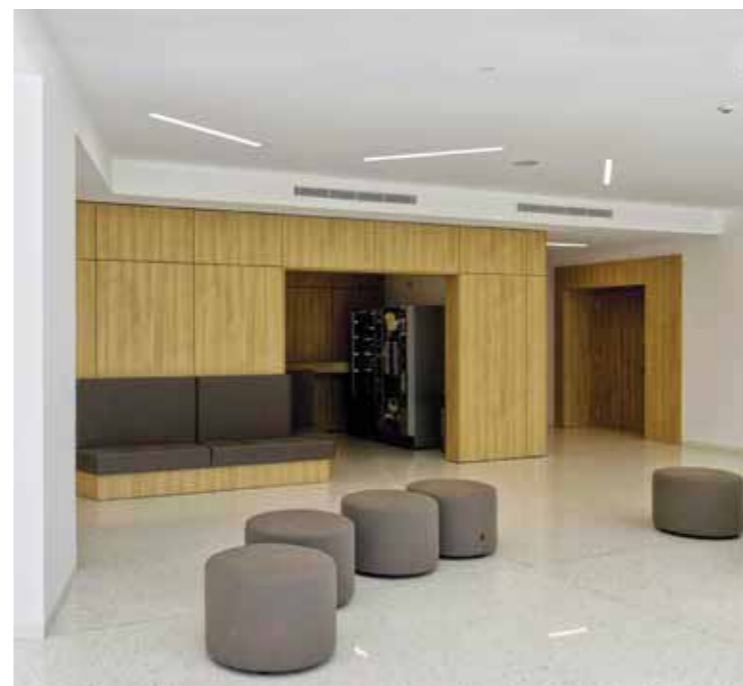

**Scuola secondaria di primo grado
Istituto Marcelline a Bolzano**

Secondary school
Marcelline Institute in Bolzano

GAM SCUOLE

GAM SCHOOLS



GAM SCUOLE

GAM SCHOOLS



Scuola dell'infanzia, primaria e secondaria
Exupéry International School a Piņķi, Lettonia

Kindergarten, primary and secondary school
Exupéry International School in Piņķi, Latvia

GAM é anche NIDI E SCUOLE D'INFANZIA

GAM also means NURSERIES AND KINDERGARTENS



GAM ha radici nella storia della pedagogia. Nasce dall'antica falegnameria della città di Gonzaga che ha prodotto i primi materiali educativi e arredi disegnati da Maria Montessori. Da allora GAM interpreta e promuove la buona pedagogia. GAM ha progettato e realizzato migliaia di nidi e scuole dell'infanzia in Italia, in Europa e nel mondo.

GAM has its roots in the history of pedagogy. It stems from the ancient carpenter's shop in Gonzaga that manufactured the first educational materials and furnishings designed by Maria Montessori. Since then, GAM has interpreted and promoted good pedagogy. GAM has designed and built thousands of nurseries and kindergartens in Italy, in Europe and in the world.

GAM é anche BIBLIOTECHE

GAM also means LIBRARIES

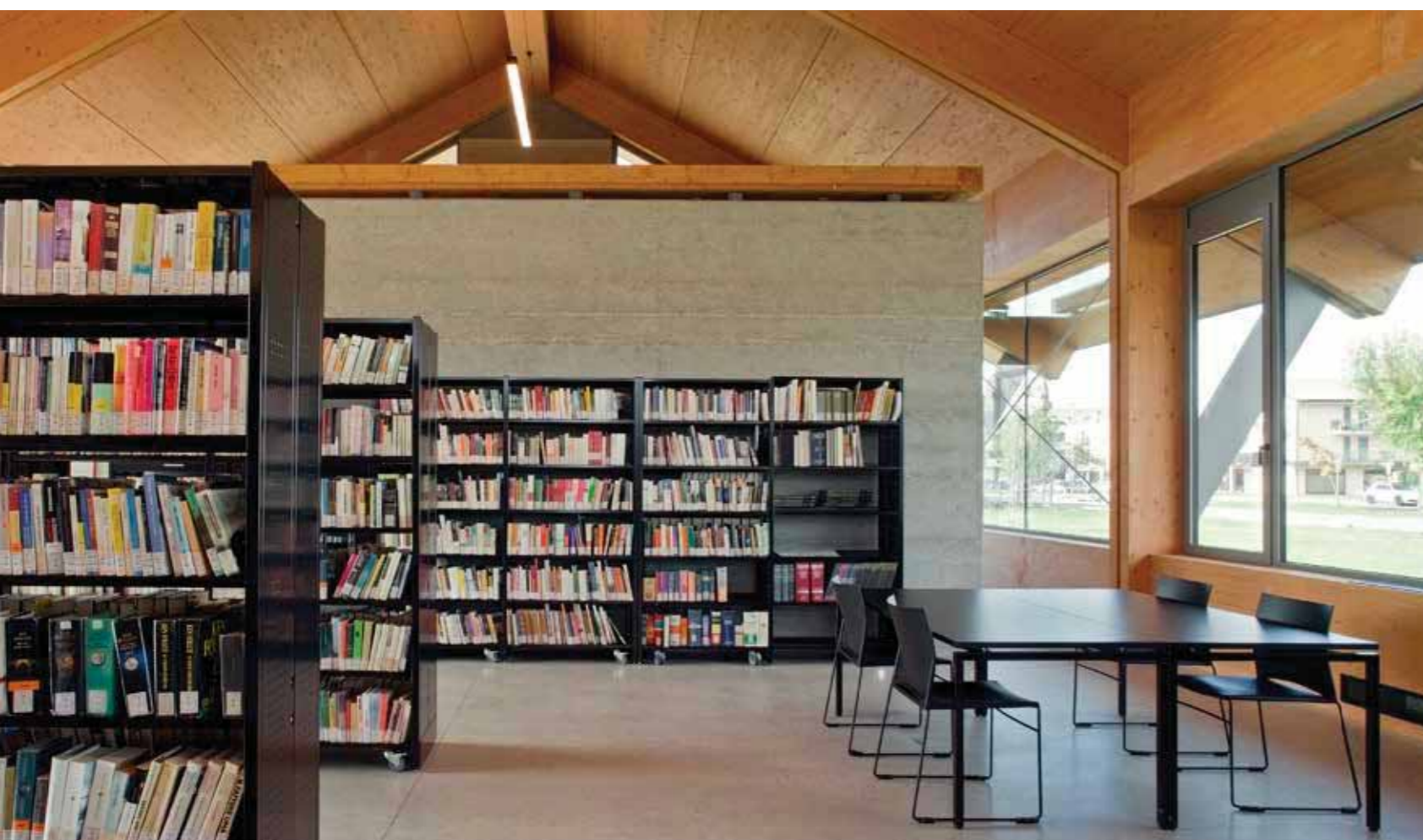

GAM progetta e realizza biblioteche e mediateche civiche, universitarie e scolastiche. GAM ha sostenuto l'evoluzione della biblioteca da luogo di consultazione e studio a centro culturale moderno, aperto a tutta la società. Bambini, ragazzi, adulti frequentano centinaia di biblioteche disegnate e arredate da GAM.

GAM designs and builds municipal, university and school libraries and media centres. GAM has supported the evolution of the library from a place of study to a modern cultural centre. Younger and older children and adults are currently enjoying the hundreds of libraries designed and furnished by GAM.

DESIGN GAM

GAM DESIGN

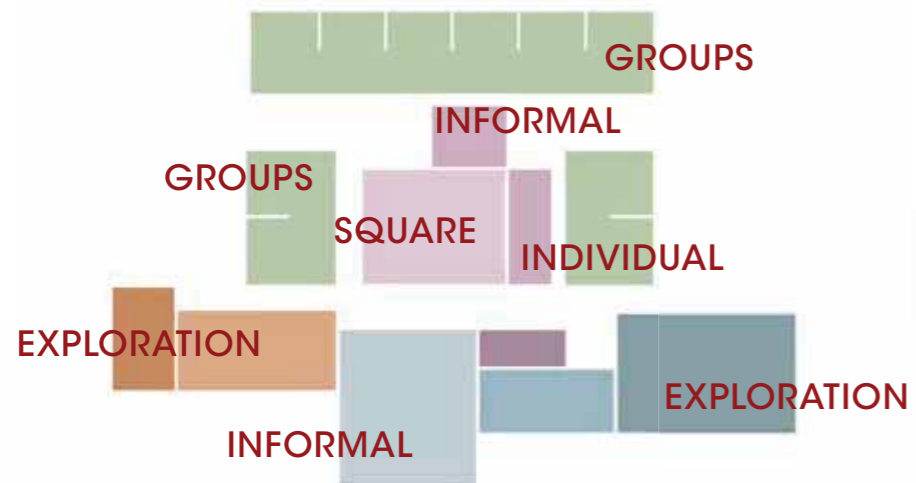

Ogni scuola è un progetto nuovo e originale. Ascolto delle esigenze, relazione con il contesto, elaborazione di soluzioni concorrono a disegnare un'idea di scuola moderna, funzionale, innovativa. Dal piano generale alla cura dei particolari, GAM prefigura spazi per le molteplici forme dell'apprendimento, dell'insegnamento, delle relazioni tra studenti e docenti.

Each school is a new and original project. Listening to needs, relating to the context, creating solutions are key to design the idea of a modern, functional and innovative school. From the general idea to the care for details, GAM designs spaces for the many ways of learning, teaching and building relationships among students and teachers.

CERTIFICAZIONI CERTIFICATIONS

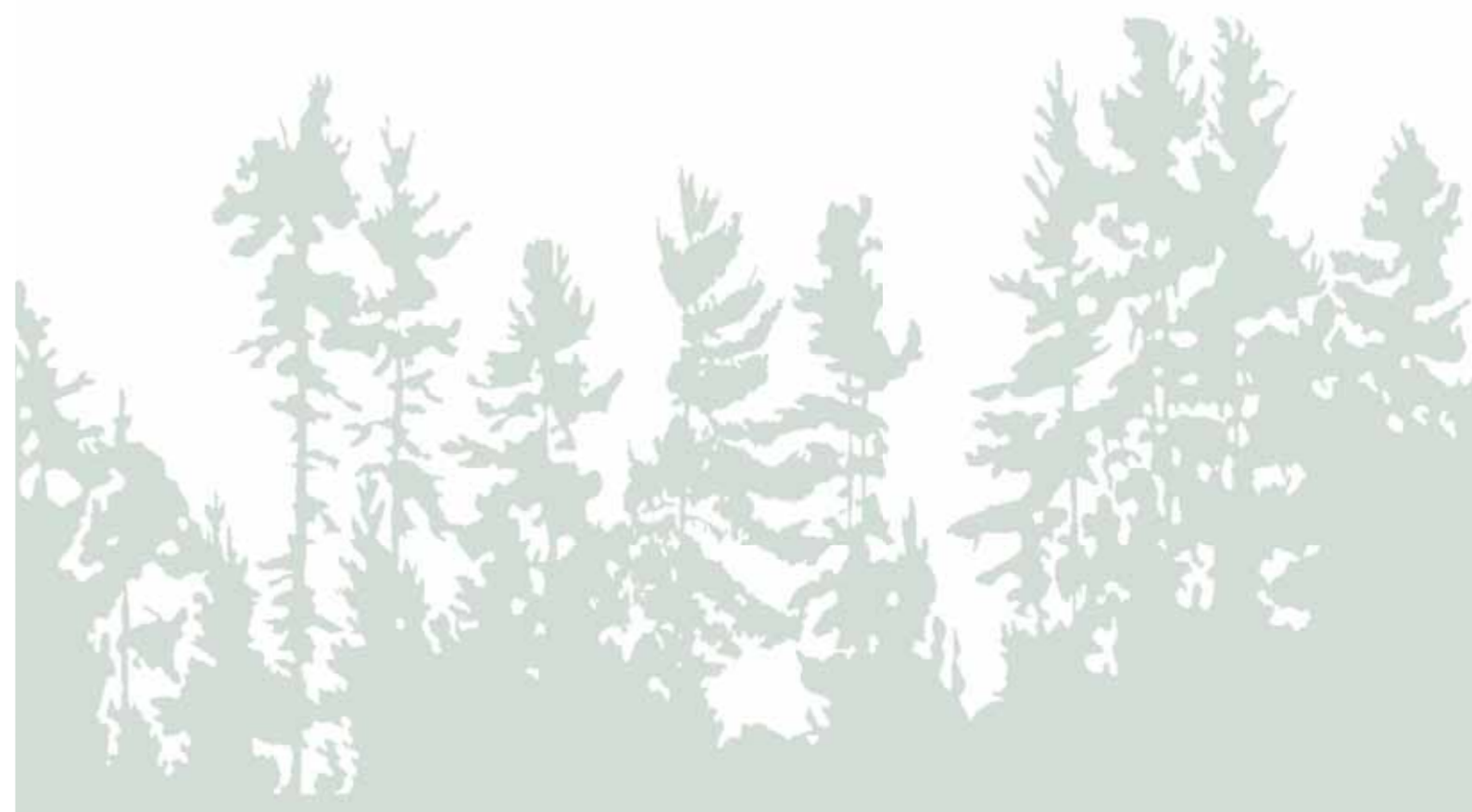

I prodotti GAM sono conformi alle norme tecniche del settore. Sono testati per sicurezza, resistenza e non tossicità. Vernici e coloranti sono atossici, contenuto di formaldeide in classe E1, imbottiti in classe di reazione al fuoco 11M, su richiesta arredi lignei in classe 1. I prodotti GAM sono conformi ai CAM (Criteri Ambientali Minimi).

All GAM products comply with the technical standards of the sector. They are tested for safety, resistance and non-toxicity. Paints and colours are non-toxic, class E1 formaldehyde content, 11M fire rating upholstery; class 1 wooden furnishing on request. GAM products comply with CAM (minimum environmental criteria).





Concept, architectural and product design,
graphic design, copyright - **Giovanni Fumagalli**
cc91 design & research

Architectural and product design - **Lorenzo Caporro**

Graphic design - **Simona Malizia**

Project management - **Alessandro Zecchin**